



RANGECOOKER USER MANUAL

PROFESSIONAL – PROLINE – SERIE K – MAJESTIC

06 - 07 - 08 - 09 - 10 - 12 - 15

USER – Use and Maintenance

INDEX

3 IMPORTANT SAFETY WARNINGS

- 10 First system startup of the oven
 - 11 Models with induction zones
 - 11 Precautions before use
 - 12 Using the Appliance
 - 13 Precautions
 - 14 In Case of malfunction
 - 14 Suggestions
-

15 INSTRUCTIONS FOR USE

- 15 First system startup of the hob
- 17 Use of a gridiron
- 18 Positioning placement of the burners
- 20 Use of the coup feu
- 21 Uso del fry-top a gas
- 22 Use of the inductive electric plate
- 25 Use of the induction hob
- 31 Use of the electric oven multifunction
- 33 Use of the conventional electric oven
- 34 5 button programmer MP
- 36 **5 button electronic programmer E3/H3**
- 39 List of functions on electric multifunction oven
- 41 List of functions on static electric oven
- 42 Functions list H3
- 43 GAS oven H3
- 45 **TFT Touch Display**
- 46 Icon legend
- 46 Settings

- 47 Cooking function setting (E3 - H3)
- 48 Cooking process (E3 - H3)
- 49 Mod. oven E3 with TFT touch (functions list)
- 50 Mod. oven H3 with TFT touch (functions list)
- 51 Mod. oven static with TFT touch (functions list)

52 Accessories

53 CLEANING AND MAINTENANCE

- 54 Replacing the bulb
 - 54 Door removal
 - 55 Cleaning the door and glasses
 - 56 Recommendations for cleaning the cooktop
 - 57 Recommendations for cleaning the oven and the front panel
 - 58 Maintenance and cleaning of total black burners
-

59 PROBLEM SOLVING

- 60 General problems
 - 60 Induction hob malfunction
 - 61 TFT display errors
 - 62 Children block
-

63 COOKIN CHART

- 64 Convection oven
- 64 Static oven
- 65 Inside food temperature (°C)

66 NOTES

IMPORTANT SAFETY WARNINGS



Characteristics of the appliances

As well as being shown on the cover, the data plate is applied to the oven door frame and is visible with the door open.

CAUTION

These warnings refer to different types of appliances. Pay attention in properly identifying the type you own (see the data plate).

These warnings are valid for the countries mentioned in the plate.

- 1 Before using the cooker, read the instructions booklet carefully. This contains very important information concerning safety during installation, use and maintenance. The instructions booklet must be kept with care for later consultation.

- 2 The electrical safety of this cooker is guaranteed only if it is correctly grounded as required by the regulations. It is fundamental to ensure that these regulations have been respected; if you are in doubt, contact a skilled technician to have the electric system accurately checked. The manufacturer is not responsible for damage caused by a bad grounding system.

- 3 **Before powering the appliance, check that the technical features shown on the data plate match those of the electrical system perfectly. Installation / regulation must be carried out by qualified personnel.**

- 4 **Make sure that air around the appliance can circulate freely.**
This appliance is not connected to an evacuation device for the combustion products, therefore the ven-tilation of the room must be analyzed carefully and according to the rules in force.

IMPORTANT SAFETY WARNINGS



-
- 5** When using a gas appliance, heat and dampness are generated inside the premise. A good aeration of the kitchen must be guaranteed by keeping the natural aeration vents open or by installing a mechanical aeration device (hood). An intensive and prolonged utilization of the appliance may result in the need of supplementary aeration, such as opening a window or increasing the power of the hood (if present).

 - 6** The alimentation cable is supplied without a plug. To connect it please refer to the paragraph “electric connection”. It is recommended to not use adapters, multiple-outlet plugs or extensions.

 - 7** When the appliance is not in use for a prolonged time, disconnect the electric power, switch off the main switch and turn off the gas.

 - 8** Do not block ventilation or heat dissipation slits.

 - 9** If the alimentation cable is damaged it must be replaced exclusively by a service center approved by the manufacturer.

 - 10** The appliance must be used only for the purposes for which it was intended. Any other use (for example, heating a room) is incorrect and therefore dangerous. The manufacturer declines all responsibilities for damage caused by similar incorrect uses.

 - 11** The appliance is not destined to be activated by means of an external timer or a remote control.



IMPORTANT SAFETY WARNINGS

-
- 12 The use of any electrical appliances requires that a number of fundamental rules must be respected:**
- A.** Never touch the appliance when you have wet or damp hands or feet;
 - B.** Never use the appliance barefoot;
 - C.** Avoid using extensions;
 - D.** Never pull the electric cable to remove it from the power socket;
 - E.** Do not expose the appliance to atmospheric agents(rain, sun, etc...);
 - F.** **Be careful: accessible parts can become very hot during the use.**
Keep children less than 8 years old far from the cooker if it is not continuously watched. This appliance may be used by children of 8 years of age or older, by people with reduced physical, sensory or mental abilities, or with lack of experience and knowledge only if they are under adequate surveillance or if they have been adequately instructed about the use of the cooker and if they are aware of the possible dangers. Children must not play with the cooker. The operations of cleaning and of maintenance must not be made by children without surveillance.
-
- 13 CAUTION: During the utilization of the appliance some parts may become very hot. Keep out of reach of children.**

IMPORTANT SAFETY WARNINGS



-
- 14 Absolutely do not touch the elements inside the oven during the utilization.**
-
- 15** Before cleaning the appliance or carrying out maintenance, disconnect the power supply by removing the plug from the socket or switching off the switch.
-
- 16** In case of breakdown or malfunction switch off the appliance and do not attempt any repairs that must only be performed by an authorized service center. Always request original parts. Failure to comply with these instructions may compromise the appliance's safety.
-
- 17** Never place unstable or deformed pans on the burners or on the electric hotplates as they could topple accidentally.
-
- 18** When the appliance is not being used, make sure the knobs are exactly in the "●"/"○"/ position.
-
- 19** Don't leave the hotplate on with no pans on it, as it would reach the temperature fast and possibly damage the appliance and your countertops.
-
- 20** The electric plates remain hot after using them. Be careful not to touch them.
-
- 21** Inflammable liquids, like alcohol or gasoline, must be kept away from the appliance.
-
- 22** Should you use small household appliances near the cooking top, please make sure that the electrical cable is not in contact with hot parts of the appliance.

IMPORTANT SAFETY WARNINGS



-
- 23** To assure the right function of gas appliance, make sure that the rooms are ventilated. Check that the installation is carried out in accordance with the instructions.
-
- 24** The materials used in producing our appliance are compatible with the environment and therefore recyclable. The packaging waste must not be left within reach of children, and must be disposed by using the appropriate recycling channels. To scrap your appliance, use your retailer and/or your local council's facilities; remember to make your appliance unusable before scrapping it.
-
- 25** If the rotation of the gas knobs is difficult, don't do anything. Close off the gas and call the After Sales Service for advice.
-
- 26** Do not use a steam cleaner to clean the inside parts of the oven.
-
- 27** Don't use any abrasive detergent or sharp device to clean the oven glass door. This may cause damage or breakage.
-
- 28** Don't modify the appliance.
-
- 29** **Be careful:** fat spillage, objects or oils on the appliance may cause a fire.
-
- 31** The appliance must be used by responsible people
-
- 32** **Be careful:** the use of inappropriate or unsuitable protections can cause fires and/or damage.
-
- 33** **Be careful:** cooking with fat or oil can be dangerous or cause fires.

IMPORTANT SAFETY WARNINGS



- 34 Fire danger:** do not store items on the cooking surfaces.

- 35 Be careful:** in the case of fire never attempt to extinguish a flame/ fire with water, but turn the appliance off and cover the flame with a lid or with a fireproof cover.

- 36 Be careful:** do not use gas burners if the flame is unstable.

- 37** Ensure that the flame diffusers are properly positioned in their seats with their respective caps.

- 38** Do not leave the cooker unguarded during any cooking that can spit fats or oils.

- 39** Do not touch the heating elements while the appliance is on. Let it cool down before cleaning

- 40** Food preparation in plastic or aluminum containers on hot cooking zones is forbidden just like the positioning on the cooking surfaces of plastic or aluminum foil objects.

- 41** Do not cover the burners or the hob with tinfoil.

- 42** Do not use the appliance's surface as a work top, sharp objects might scratch it.

- 43** Be careful: do not use frying pans, saucepans, grills or stones for grilling of a greater size than the maximum ones indicated for each single burner; above all they must not cover more than one burner at the same time. The heat accumulation might damage the cooker.

- 44** In case of liquid spilling over, remove it from the hob.

IMPORTANT SAFETY WARNINGS



-
- 45** Do not place empty saucepans on the cooking areas.
-
- 46** The cooking areas, must not work empty, without saucepans.
-
- 47** Do not place empty pans on the cooking zones.
-
- 48** The cooking zones must not work empty, without pots.
-
- 49** During operation, the surfaces of the heated drawer can get hot.

IMPORTANT SAFETY WARNINGS



- First system startup of the oven



When using the oven for the first time, let it work empty for about 1 hour (230 °C), possibly leaving the kitchen windows open.

When you first turn the oven on, a bad smell is emitted due to production residues such as grease, oils or resins.

When the oven has cooled clean it following the instructions in the «Cleaning and care section».

Once the indicated time has elapsed, the oven is ready for its first cooking. Do not cover the inside of the oven with aluminium foil to facilitate the cleaning.

This operation alters the appliance's performance and can damage the enamel.

All accessories in direct contact with food must be thoroughly cleaned using suitable products before their first use.

Cooking food in direct contact with grills and oven trays is not allowed



IMPORTANT SAFETY WARNINGS

- Models with induction zones

**Read
carefully
before using**

- Only qualified technicians should install the appliance. The technician will not be held responsible for any damages caused by electrical malfunctions.
- The hob must be installed in the appropriate inset.
- The appliance should be used solely for cooking foods, excluding any other domestic or industrial uses.
- Remove the adhesive labels from the glass on the hob.
- Do not modify or alter the appliance.
- Do not use the hob as a working zone.
- The appliance must be connected and installed in compliance with current local regulations.
- Do not use extension cables for connections.
- This appliance is not intended for use by persons (including children) with reduced physical, sensory or mental capabilities, or lack of experience and knowledge, unless they have been given supervision or instruction concerning use of the appliance by a person responsible for their safety. Children should be supervised to ensure that they do not play with the appliance.
- **WARNING:** Accessible parts may become hot during use. To avoid burns young children should be kept away.

IMPORTANT SAFETY WARNINGS



- Models with induction zones

Using the appliance

- After use, switch off the cooking area using its control device and do not rely on the pan detector.
- **WARNING:** leaving the appliance unattended with objects, grease and oils can be dangerous and can cause a fire.
- **WARNING:** in the event of a fire, never attempt to put out a flame / fire with water, but turn off the appliance and cover the flame with a lid or a fireproof blanket for example.
- Cleaning and maintenance operations must not be carried out by unsupervised children.
- Make sure that the power cable does not come into contact with the glass or the pan.
- Magnetic objects such as credit cards, floppy disks, calculators, must not be placed near the appliance in operation.
- Não utilize nenhum tipo de objeto metálico, exceto as panelas específicas para a indução.
- Do not use any type of metal object except the cookware suitable for induction.
- The appliance must be used by responsible personnel.
- Metal objects such as knives, spoons, forks or lids should not be placed on the surface of the hob because they can get hot.
- If the surface is cracked, switch off the appliance to avoid the possibility of electric shock.

IMPORTANT SAFETY WARNINGS



- Models with induction zones



- **WARNING:** the appliance is not designed to work with an external timer or with a remote-control system
- **WARNING:** do not use steam appliances to clean the hob

Precautions

- Unsuitable pans could ruin the hob's surface.
- Do not use abrasive materials for cleaning.
- Avoid dropping heavy objects onto the hob's surface.
- Gently place the cookware on the hob.
- Make sure that appliance ventilation complies with the instruction manual.
- Do not put empty pans on the hob.
- Sugar, synthetic materials, or aluminium materials must not come into contact with the cooking areas.
- Avoid placing hot containers on the display.

IMPORTANT SAFETY WARNINGS



- Models with induction zones

In case of malfunction

- When a malfunction occurs turn off and disconnect the appliance.
 - If cracks appear on the glass or it is broken, disconnect the appliance and contact your authorized service centre.
 - Any repairs should be made by authorized personnel.
-

Suggestions

- Make sure that the pot is in the middle of the cooking zone. Ideally, the bottom of the pot should cover the entire cooking zone.
- The magnetic field produced by the induction hob could affect the proper working of pacemakers. Detailed information should be obtained from your doctor.
- Avoid placing synthetic materials or aluminium objects in contact with the cooking zone.

INSTRUCTIONS FOR USE

- First system startup of the hob

BE CAREFUL:

keep children and disabled people away during the operation. Do not use the appliance as a heating source.

General notes

to keep the appliance efficient and safe, maintenance must be entrusted to specialized technicians or to the after-sales service staff. Choose covered pans based on the quantity of food to cook.

IMPORTANT



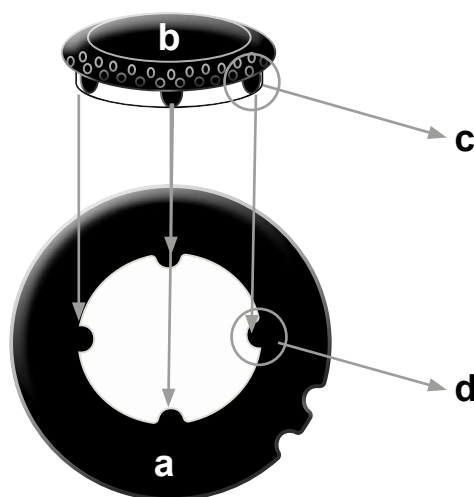

Position the flame divider "b" correctly. To do this, align the 4 teeth "c" of the flame divider with the recess "d" of the aluminium Cup "a".



Lighting the burners

The index above the knobs will help you to find the corresponding burner. Press the knob by turning it anti- clockwise and bring it to the ignition position; keep the knob pressed for about 5 seconds so that upon its release the flame remains alight (in case of unsuccessful ignition repeat the operation).

Symbol Function

-  off
-  maximum
-  minimum
-  index

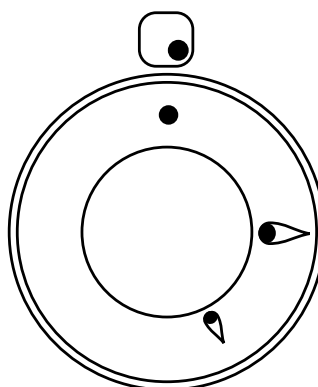

INSTRUCTIONS FOR USE

- First system startup of the hob

Recommended pans according to burner size:



Burners	ID	Diameter Ø (cm)
Medium	SR	10 ÷ 20
Large	R	20 ÷ 24
Fish burner	P	oval pans (380 x 185)
Ring	TC/DCC	22 ÷ 28
Dual - Ring	DUAL	10 ÷ 30

Accensione del bruciatore Tripla corona "DUAL"

Identify the knob with the help of the index near the knobs. Press and turn the knob to the symbol (maximum) for 5 seconds. Once the burner is on, by turning the knob counterclockwise it gets to its first block that corresponds to the middle one. By applying a bit of force, the first block is exceeded and the outer ring goes out leaving only the little central burner turned on called AUXILIARY. To adjust the auxiliary burner on minimum, rotate the knob counterclockwise until it stops. At this point, to turn the burner back on, rotate the knob clockwise up to the desired value.

Symbol Function

	off
	maximum
	minimum
	index

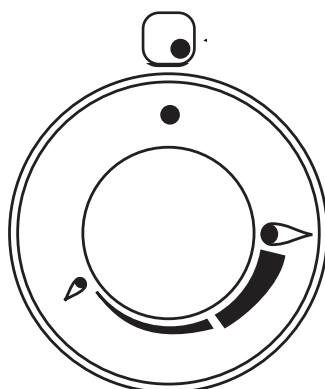

INSTRUCTIONS FOR USE

– Use of a gridiron

Gridiron

If you want to use a grill, there are a few things to consider:

- it is possible to preheat the grill to the maximum burner power for no more than 10 minutes;
- we recommend cooking foods with reduced power;
- make sure that the burner flames do not come out from the edge of the grill;
- maintain at least a distance of 150 mm from the side wall to the edge of the grid;
- do not place the grill on more than one burner at the same time.

Correct



Be careful: wrong



Be careful: wrong

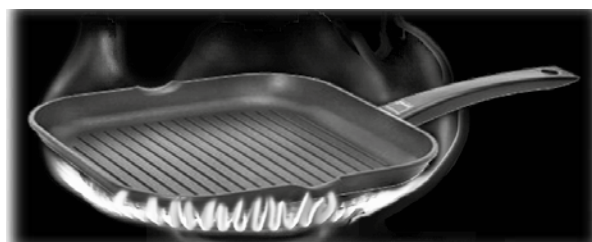

INSTRUCTIONS FOR USE

– Positioning placement of the burners

Positioning of the burners



BE CAREFUL: always check that the burners are properly positioned), with a uniform flame that is not noisy.

BURNERS	RIGHT	WRONG
Medium		
Large		
Dual Ring		
Fish burner		

Always check that the screws below the burner are fixed

INSTRUCTIONS FOR USE

– Positioning placement of the burners

Positioning of the burners



BE CAREFUL: always check that the burners are properly positioned, with a uniform flame that is not noisy.

BURNERS	RIGHT	WRONG
Medium		
Large		
Dual Ring		

INSTRUCTIONS FOR USE

– Use of the Coup feu

COUP FEU

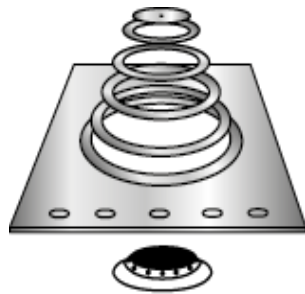

Fig. A



Fig. B



Fig. C

Functioning

The large “Coup feu” solid cast iron plate made of concentric rings allows you to rest the pan (or even several pans) directly on the surface (fig. B, C). It is heated by means of a gas burner (fig. A). The plate is designed to provide a moderately intense heat which is well distributed over the surface.

This is ideal for slow cooking and particularly for sauces, browning and grilling, heating dishes or keeping them warm. Switch the burner on 15/20 minutes before use to allow the cast iron plate to accumulate heat.

You will then be able to use the plate even when switched off for a further 10/15 minutes. The middle of the plate is the area where the highest temperatures are reached whereas the outer part is cooler. By simply moving the pan from the middle to the outside of the plate, you can obtain different cooking intensities without regulating the flame. Pan dimensions permitting, several dishes can be cooked at the same time (fig. C). If necessary it can be used as a handy top, providing ample space for resting pots and pans.

Cleaning the Coup feu plate

The hotplate should be cleaned while still warm using the products normally used in the kitchen for metal surfaces. Rub with a wire pad, following the direction of the satin finish. Dry well immediately. If you want to give the plate a better appearance, after cleaning, apply a coat of a specialist cleaning paste / cream.

If you do not intend to use the hotplate for long periods, after normal cleaning apply a thin film of liquid paraffin (Vaseline oil) with a wad of cotton wool. This treatment is necessary to prevent any formation of surface oxides.

When next turning on the plate you will notice the evaporation of the paraffin oil used. This phenomenon will disappear in a few seconds.

The hotplate may sometimes present phenomena of surface oxidation due to the presence of humidity, but above all due to lack of use. You are therefore advised to use it frequently to prevent any oxidation. Never leave the hotplate damp. If the oxidation phenomenon still appears, use lightly abrasive paper to remove the oxidation, taking care to rub gently, always in the direction of the plate satin finish.

Do not cook food directly on the plate surface. Always use suitable containers.

INSTRUCTIONS FOR USE

– Use of the gas fry-top

FRY-TOP A GAS

A = cooking area

B = drip tray

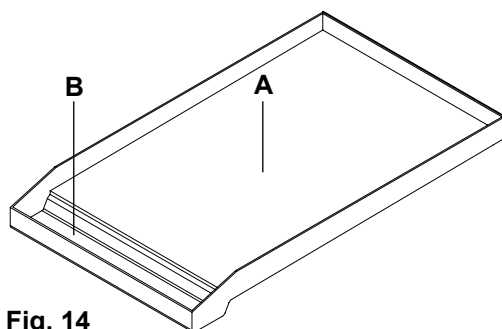

Fig. 14

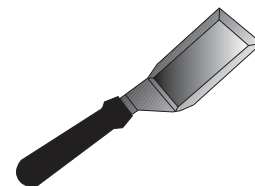



Fig. 15

Functioning of the appliance

The fry-top (fig. 14) consists of a stainless-steel plate, suitable for contact with food [] with a uniformity of temperature on the cooking surface and with a very low heat loss. To use the appliance, light the flame below the plate by means of the corresponding knob (see “Lighting the burners”) and ensure that there is a flame. Turn the knob to maximum for about 10 minutes and wait for the plate to heat up. Once this time has elapsed, the plate is ready to start cooking.

By adjusting the flame, there is no limit to your culinary imagination. If you turn the control knob to the low setting, this allows slow or dietetic cooking. Higher temperatures are suitable for cooking meat, fish and vegetables. The Fry-Top plate is ideal for Oriental cooking with an optional accessory (lid) needed for this type of cooking.

Some models are supplied with the spatula shown in figure 15, which is useful both for cooking and for cleaning the plate.

Cleaning and care

It is recommended to clean the plate thoroughly at the end of each cooking session. With the plate hot and the flame at minimum, remove the cooking residue using the scraper provided (fig. 15). Pour a little water onto the plate and, still using the scraper, continue cleaning the plate. Once the water has completely evaporated, repeat the same operation even several times until the desired result is obtained. It is extremely important to clean the plate when it is quite hot.

Adjuster (Knob)

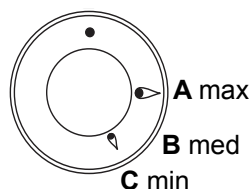

Type of cooking	Knob posit	Time min.
Egg	B	2
Sliced aubergines (0.5 cm thick)	B	9 ÷ 13
Sliced potatoes	B	5 ÷ 73
Sliced courgettes	B	3 ÷ 5
Fish (sea bream weighing about 200 g)	B	15
Hamburger	B	10
Beef steak	B	3
Porterhouse (2 cm thick)	A	5

INSTRUCTIONS FOR USE

– Use of the inductive electric plate

INDUCTIVE ELECTRIC PLATE

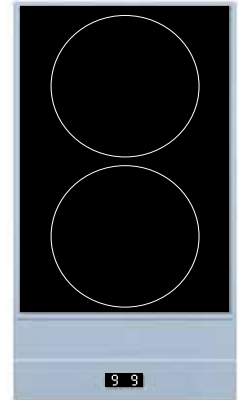
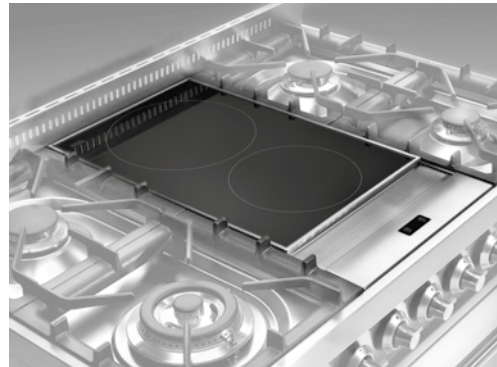

ATTENTION!

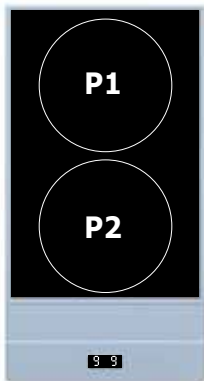

The ceramic hob remains hot for a long time after use. Do not touch the hob with your hands or let children near it. The residual heat indicator will remain on until the hob has cooled down.

If any cracks appear in the ceramic hot, disconnect the appliance immediately from the mains and call an authorized technical service centre.

The positions are clearly indicated by the rings.

Area	Diameter Ø	Power
P1	220 mm	1800 W
P2	180 mm	1800 W

Precautions to avoid damaging the appliance

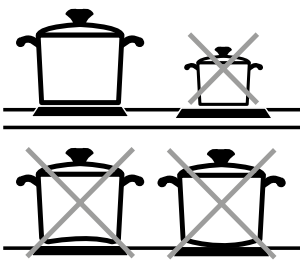

Heat zones are clearly indicated by these circular areas. When one or more cooking areas are being used, the remaining surface stays cold. Each cooking area is designed to work with the cookware specific for induction cooking, with a diameter just less than the diameter of the selected cooking area.

The bottom of the pan must be thick and flat. Its diameter must be as similar as possible to that of the cooking ring. The surface of the hob and the bottom of the pan must be kept clean.

- Do not wet or overheat the heating plates.
- Avoid sudden changes in temperature on the ceramic hob. For example, do not pour cold water onto the hot hob.
- Do not leave the pan handles sticking out as they could be spilled accidentally.

It is preferable not to cook on the ceramic hob with pans that have been used on gas burners. The flames will have deformed the bottom of the pans.

Ventilation

Ventilation of the hob is completely automatic. The cooling fan for the electronics located under the hob works at slow speed up to the temperature level of the electronics. When the hob is used for a long time the speed of the cooling fan increases. As soon as the electronics have been cooled the fan stops automatically.

INSTRUCTIONS FOR USE

– Use of the inductive electric plate

First switching on

Clean the hob's surfaces with a damp cloth.

Switching on one cooking area

A cooking area is turned on by turning the relative knob clockwise. On the hob's display the set power level (from 1 to 9) appears.

Switching off a cooking area

A cooking area is turned off by turning the relative knob anti-clockwise. On the hob's display a [0] appears for 3 seconds, after which it disappears from the display

Automatic switching off

The appliance switches off automatically when there are overheating or supply error conditions.

Cookware presence recognition

Each cooking area is designed to work with specific pots for induction cooking with a diameter just less than the diameter of the selected cooking area.

If the pot is unsuitable, the display shows the symbol for the area without a pot (U) and the appliance will not operate. This prevents the switching on until a pan is placed on the cooking area or until a suitable pot for induction is used. If you remove the pot during operation, the area is switched off.

Pot recognition lasts 9 minutes, if after this time no suitable pot is used, the area is switched off. The area's display changes from "absent pot" to [-].

Afterheat indication

If the cooking area, when turned off, is still very hot, the display shows the symbol H.

"Heat-up" function

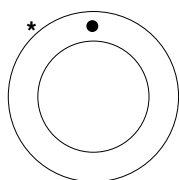

The heat-up, or quick heat function, is available on each cooking area. This means that for a well defined time, the cooking area operates at maximum power and at the end of this time the power is automatically adjusted to the set level. The duration is, in this case, according to the set power level. The heat-up function starts by turning the knob anti-clockwise, from 0 up to its end [*] (Fig. 10). Once the control is turned left, an [A] appears on the relative area's display. After initiation a power level must be set within 3 seconds by turning the knob clockwise for the cooking's duration; if this does not happen, the heat-up function is interrupted.

Key-lock function

The key-lock function is useful where children are present. However, the presence of an adult is advisable when the appliance is working.

Activating the Key-lock function, all cooking areas are off and cannot be accidentally turned on. The Key-lock function is activated, with the knobs at 0, by rotating one of the two induction area's controls anticlockwise for 3 seconds. [L][L] appears on the display. By repeating this operation the Key-lock function is deactivated. [0] appears on the display.

If a control is turned with the key-lock on, [L][L] appears on the display.

INSTRUCTIONS FOR USE

– Use of the inductive electric plate

Display



Displayed value

Description

1 - 9	Level of power - Select the cooking level
A	Heat-up
H	Residual heat - The cooking zone is hot
U	Presence of pot - Absence of pot or unsuitable pot
E	Error - Cooking zone anomaly

Limitation of the duration of operation

A maximum time of continuous operation is associated with each cooking area. This depends on the set power level. If the limit of the duration of operation is reached, the respective area is switched off.

Limitation Level approximate duration of operating power (hours)

Level	Duration (hours)1-9
1	8.5
2	6.5
3	5
4	4
5	3.5
6	2.5
7	2
8	1.5
9	1.5

Cooking tips

SAUCEPANS

Suitable materials: steel, enamelled steel, cast iron, ferromagnetic steel, aluminium with ferromagnetic bottom. Unsuitable materials: aluminium and steel without ferromagnetic bottom, copper, ceramic, porcelain, glass, brass. To check the pan's compatibility, place it with a minimum amount of water on the cooking area. By turning to position "9" the water must boil in a few seconds.

Try with a magnet on the bottom of the pan.

During cooking some pans create "noise". This phenomenon does not derive from the induction hob and does not influence cooking.

SAUCEPAN SIZES

The cooking areas automatically adapt to the diameter of the pans. However, the bottom of these pots must have a certain minimum diameter to operate correctly. To obtain the maximum efficiency of the hob, place the pan in the centre of the cooking area.

Operation table

(purely indicative values)

Knob position

Type of cooking

1-2	melt butter, chocolate etc.
2-3	heat small quantities of liquids, keep food warm, prepare sauces.
4-5	heat solid foods, defrost frozen foods, omelettes with 2-3 eggs, fruit and legumes.
5-6	cook meat and fish, legumes in sauce, dishes with water, jam preparation.
6-7	roast meat or fish, steaks, liver, eggs.
8-9	boil large amounts of water, fry potatoes etc.

INSTRUCTIONS FOR USE

– Use of the induction hob

INDUCTION HOB

Mod. PI06....

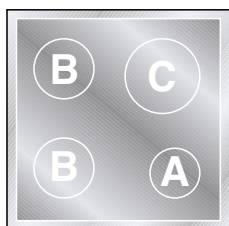

Mod. PI09 - MI09 - PDI09

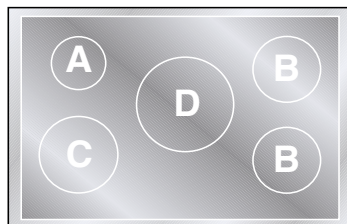

Mod. PDI10 - MDI10....

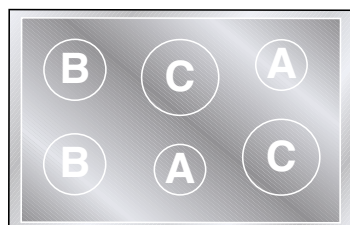

Mod. PBI09 - MBI09 -
PDBI09 - LBI09....

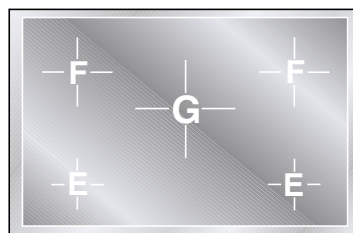

Key

A - ø145 - Cooking area ø 145mm
(1400W / Booster 2200W)

B - ø180 - Cooking area ø 180mm
(1850W / Booster 3000W)







C - ø210 - Cooking area ø 210mm
(2300W / Booster 3700W)

D - ø260 - Cooking area ø 260mm
(2600W / Booster 3700W)

E - ø175 - Cooking area ø 175mm
(1400W / Booster 2000W)

F - ø215 - Cooking area ø 215mm
(2300W / Booster 3000W)

G - ø265 - Cooking area ø 265mm
(2300W / Booster 3000W)

Mod.	A ø145	B ø180	C ø210	D ø260	E ø175	F ø215	G ø265	E03E 	E03 	E04E 	M06E3 	M06MP 	M09E3 	M09MP 	kW (230V)	kW QuickSart
PI06 - MI06	1	2	1	-	-	-	-	-	-	-	1	-	-	-	9,85	10,60
PI09 - MI09	1	2	1	1	-	-	-	-	-	-	-	-	1	-	13,85	14,50
PBI09 - MBI09	-	-	-	-	2	2	1	-	-	-	-	-	1	-	13,85	14,50
LBI09...	-	-	-	-	2	2	1	-	-	-	-	-	-	1	13,85	14,50
PDI09 ...	1	2	1	1	-	-	-	1	-	-	1	-	-	-	15,85	16,60
PDBI09...	-	-	-	-	2	2	1	1	-	-	1	-	-	-	15,85	16,60
LDBI09...	-	-	-	-	2	2	1	-	1	-	-	1	-	-	15,15	15,90
PDI10...	2	2	2	-	-	-	-	-	-	1	1	-	-	-	16,10	16,85
MDI10 ...	2	2	2	-	-	-	-	1	-	-	1	-	-	-	15,85	16,60

INSTRUCTIONS FOR USE

– Use of the induction hob

Before the first use

Clean your hob with a damp cloth, and then dry the surface thoroughly.

Induction

There is a coil underneath each cooking zone which, when a pot is placed on it, generates a variable electromagnetic field, producing inductive power of a ferromagnetic substance on the bottom of the pot. The end result is that the bottom of the pot placed above the cooking zone is heated. The type of material constituting the pot is fundamental:

- All pots with a ferromagnetic bottom are suitable (this can be verified with a magnet)
- The following pots should not be used: copper, stainless steel, aluminum, glass, wood, ceramics

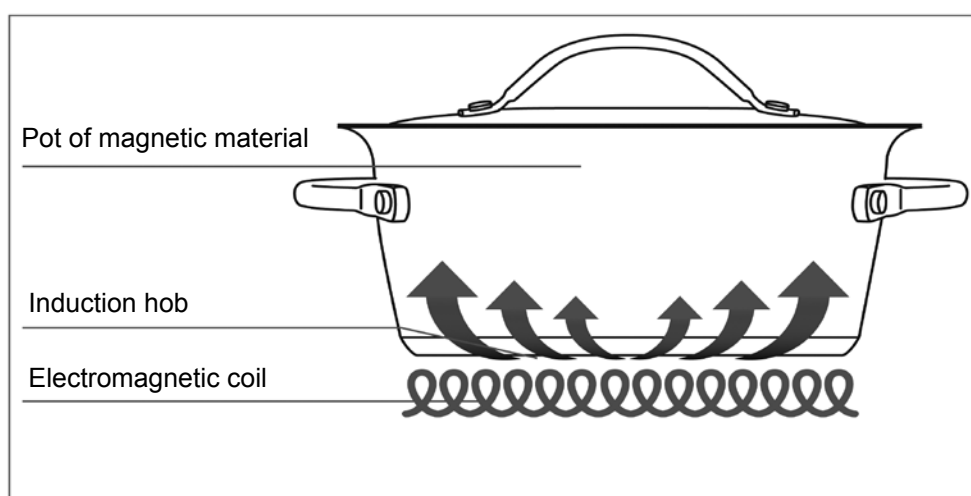

Adjuster (Knob)

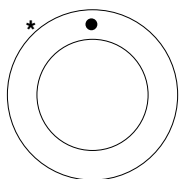

The knob does not show any numbers, the power level will be visible on the display.

Switching on a cooking area

Turn the relevant knob clockwise. On the hob display the set power level will appear (from 1 to 9)

Switching off a cooking area

A cooking area is switched off by turning the respective knob counterclockwise. The symbol [0] appears on the hob display for 15 seconds, then it disappears from the display or changes to the symbol [H] if the cooking area is still hot.

Automatic switching off of the device

The device switches off automatically if any conditions of excess temperature or errors in the power supply occur.

INSTRUCTIONS FOR USE

– Use of the induction hob

Booster function

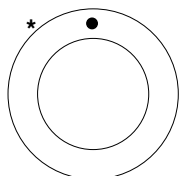

fig. A

The purpose of the booster function is to give more power to a determined area in order to reduce the necessary cooking time. This function is activated by turning the knob clockwise from position 0 (off) to the final position (* fig. A). After short acoustic signal, the symbol [P] appears on the display, meaning that the booster function is activated. The Booster function has a maximum duration of 10 minutes. The area concerned then returns to level [9]. The Booster function ends before this time when:

- a lower power level is set;
- the pan is removed;
- there is overheating of the appliance or of the heating area.

The Booster function has precedence over the “Heat-up” function.

Recognizing the presence of a pan

Each cooking area is designed to operate with specific pans for induction cooking, having a diameter just smaller than the diameter of the chosen cooking area. If the pan is not suitable, the display for the area shows the symbol indicating absence of the pan (U) and the appliance does not start up. This prevents the appliance from being switched on until a container is placed on the cooking area, or until a container suitable for induction is used. If the container is removed during the operation, the area is switched off. The duration of pan recognition is 10 minutes; if no suitable container is used on the cooking area during this time, the area is switched off. The area display changes from the [U] symbol to the [-] symbol.

Residual heat indication

If the cooking area is still very hot, even though it is switched off, the symbol H appears on the display. The Heat-up function, or quick heating, is available on each cooking area. This means that for a well-defined time the cooking area works at maximum power and at the end of this time the power is automatically brought to the set level. In this case the duration depends on the selected power level. The Heat-up function is activated by turning the knob counterclockwise from position 0 to the final position (* fig. A) for 2 seconds. After short acoustic signal, a letter [A] is shown on the display for the correspondent area. After it has been activated you must set a power level to continue cooking within 10 seconds; if this is not done, the Heat-up function is interrupted.

“HEAT-UP” function

KEY-LOCK function

The Key-lock function is useful if there are children at home. However, it is always advisable for an adult to be present when the appliance is in operation. When the Key-lock function is activated all the cooking areas are switched off and they cannot be switched on accidentally.

INSTRUCTIONS FOR USE

– Use of the induction hob

4 zones models only

The Key-lock function is activated, with the knobs in position 0, by turning the controls 2 and 3 in a counterclockwise direction.

The letters [L][L][L][L] appear on the display. The Key-lock function is deactivated by repeating the same operation. The letters [O][F] appear on the display. If a knob is turned when the key-lock function is active, the letters [L][L][L] appear on the display.

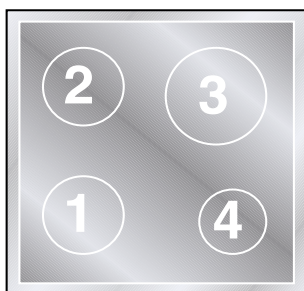

5 or 6 zones models only

The Key-lock function is activated, with the knobs in position 0, by turning the controls 1 and 2 simultaneously in an counterclockwise direction.

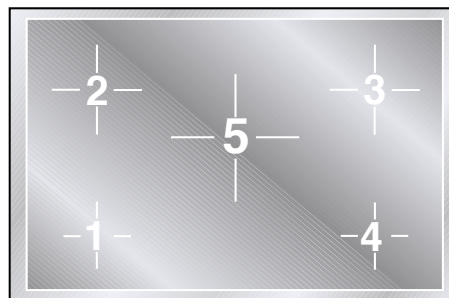
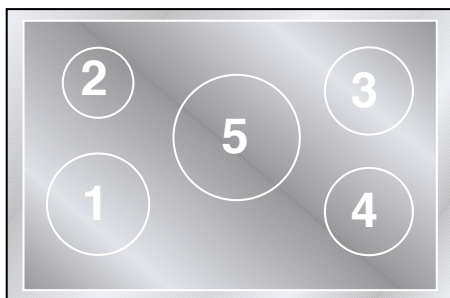

INSTRUCTIONS FOR USE

– Use of the induction hob

Heating function 42° AND 65°

Turn the knob (A) clockwise. Between the off position (0) and the power position (1) there is the position (u) which identifies the function for heating food at 42°. Only for 5 and 6-zone models: turn the knob (A) clockwise again. Between the (u) position and the power position (1) there is the position (U) which identifies the function for heating food at 65°. The maximum time of use for both functions is limited to 120 minutes. Both functions are prioritized over the 'HEAT-UP' mode.

Display

A display is associated with each cooking area.

- Set power level: (1-9)
- Food heating 42°-65° (U)
- Booster: (P)
- Heat-up: (A)
- Residual heat: (H)
- Pan absent or not suitable: (U)
- External error: (E)
- Fault: (F)
- Knob permanent rotation: (_ □)

Limit of the duration of operation

A maximum time of continuous operation is associated with each cooking area. This depends on the selected power level. If the limit of the duration of operation is reached, the respective area is switched off.

Power level	Approximate limit of the duration of operation (hours)
U	2
1	6
2	6
3	5
4	5
5	4
6	1,5
7	1,5
8	1,5
9	1,5
P	(10 min. [P], later 80 min. [9])

INSTRUCTIONS FOR USE

– Use of the induction hob

Power management

The power management, in case the booster function is being used, is performed in the following way: the level set cooking more recent priority over other areas. The activation of a cooking zone is not shown on the display when prompted for a power too high. In this case only after having decreased the power level by turning the knob of the cooking zone counterclockwise the regular operation starts with the relative power display in use on the display.

Overheating of cooking zone

During operation, if a cooking zone overheats too much, the power is reduced automatically and the display shows the new level just edited. At this point it is only possible to decrease the power level. As soon as the temperature of the cooking zone falls below the critical value it will possible to restart the cooking normally.

Suggested cooking functions (purely indicative)

Knob position	Type of cooking
1-2	Melting butter, chocolate, etc.
2-3	Heating small amounts of liquids, keeping food warm, preparing sauces.
4-5	Heating small amounts of liquids, keeping food warm, preparing sauces.
5-6	Cooking meat and fish, pulses in sauces, dishes with water, making jam.
6-7	Roasting meat or fish, steaks, liver, eggs.
8-9	Boiling large amounts of water, frying chips, etc.

INSTRUCTIONS FOR USE



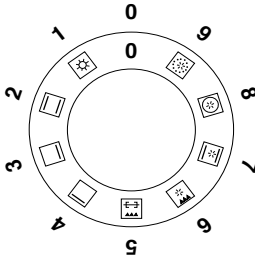
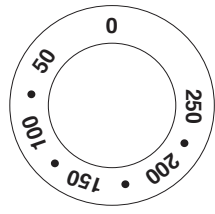





– Use of the electric oven multifunction (Pro Line)

<p>Description</p> <hr/> <p>S. Selector</p> <hr/> <p>T. Thermostat</p>	<div style="display: flex; justify-content: space-around; align-items: center;"> <div style="text-align: center;"> <p>S</p>  </div> <div style="text-align: center;"> <p>T</p>  </div> </div>
<p>Command of the oven multifunction</p>	<p>S. Multifunction electric oven selector T. Temperatures, from 50°C to 250°C, can be selected by using this knob.</p>
<p>Turning on and off</p>	<p>Choose one of the cooking operations by turning the selector (S) and adjust the temperature (from 50° C to 250° C) with the thermostat (T). We recommend putting into the oven after preheating.</p>
<p>Safety thermostat</p>	<p>The oven is equipped with a safety thermostat, which switches off the electric power. The resetting of the thermostat, according to the decrease in the temperature of the oven, is automatic. The oven can be used again when cooled down. In case the safety thermostat acts because of a defect of the components, you are requested to call the After Sales Service.</p>
<p>Function oven</p>	<p>Choose one of the cooking functions by turning the selector (S) and adjust the temperature (from 50 ° C to 250 ° C) with the thermostat (T). If your model is equipped with a programmer, prepare it for cooking.</p>
<p>Oven light</p>	<p>To turn the light off or on gently press the selector knob (S). The light does not work if the selector is set to (0).</p>

INSTRUCTIONS FOR USE

– Use of the electric oven multifunction (Pro Line)

– Functions list

Pos.	Symbol	Function
1		Pizza cooking This function is particularly suitable for cooking pizza, focaccia and bread. The main source of heat is from the bottom heating element that works in combination with the oven's other resistances.
2		Normal static cooking It is the oven's classic function particularly suited to cooking the following foods: pork chops, sausages, cod, braised beef, game, roast veal, meringues and biscuits, baked fruit, etc.
3		Cooking from underneath This is the most suitable mode to finish the food cooking, in particular confectionery (biscuits, meringues, leavened cakes, fruit desserts, etc.) and other foods.
4		Cooking from above Especially suitable for browning and to give the final touch of colour to many foods; it is recommended for ham- burgers, pork chops, veal steaks, sole, cuttlefish, etc.
5		Closed door grill cooking The suitable function for fast and deep grilling, to brown and roast meats in general, fillet steaks, Florentine steaks, grilled fish and also grilled vegetables. Cooking with the electric grill must be made with the thermostat at 180 °C.
6		Fan grill cooking Particularly fast and deep with significant energy savings, this function is suitable for many foods such as pork chops, sausages, pork or mixed spits, game, gnocchi alla romana, etc. Cooking with the electric grill must be made with the thermostat at 180 °C.
7		Intensive cooking Is the quick and intense cooking function for various dishes; best for: baked fish, braised vegetables, spits, duck, chicken, etc.
8		Multiple fan cooking It is the function that allows simultaneous cooking of different dishes without the smells blending; you can cook lasagne, pizza, croissants and brioches, tarts, cakes, etc.
9		Quick Start (only available for some models) This function is used to speed up the preheating of your oven. We suggest you use this function when setting a cooking temperature between 200 and 250° C. Using the QuickStart function for temperatures below 200° C does not offer particular advantages. To use the Quick Start function, turn the selector knob (S) until it is positioned on the symbol (9), then set the desired temperature with the thermostat knob (T). Once the oven has reached the temperature, the orange thermostat light goes off and the oven is ready to receive the food to be cooked. At this point, set the desired cooking function. CAUTION: the Quick Start function is not suited to cooking food, it only serves to preheat the oven more quickly. DO NOT USE THE QUICK START FUNCTION FOR MORE THAN 20 MINUTES.

INSTRUCTIONS FOR USE

– Use of the conventional electric oven (Pro Line)

Description

Choose one of the 4 cooking functions by turning the selector (S) and adjust the temperature (from 50°C to 250°C) with the thermostat (T). If your model has a programmer, set it for cooking.

S. Selector

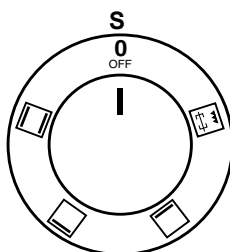

T. Thermostat

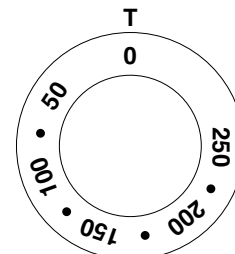

Functions list

Pos.	Symbol	
1		<p>Upper & lower elements Is the classical function of the electric oven and particularly adapted for cooking: pork chops, sausages, dried salt-cured cod, pot roast, game, roast veal, meringues and biscuits, baked fruit, etc.</p>
2		<p>Lower element This setting is most suitable for finishing cooking, particularly pastries (biscuits, meringues, desserts, puff pastry, fruit cakes, etc.) and other foods.</p>
3		<p>Upper element Especially suitable for browning and to add the finishing touches of colour to different dishes. We suggest this setting when cooking hamburgers, pork cutlets, steaks, sole, cuttlefish, etc.</p>
4		<p>Grill-baking A suitable setting for grilling au gratin and roasting quickly and well, meat in general, fillet, T-bone steak, grilled fish and vegetables too. Cooking by electric grill must be done with the thermostat set at 180°C.</p>

ISTRUZIONI PER L'USO

– 5-button electronic programmer MP (Pro Line)

Functions

Cooking time • end of cooking • clock • timer • manual function

Display

Symbols indicating functions in progress:



Timer



Duration and manual function



Automatic program

Button legend



Button for timer and buzzer



Automatic cooking duration



End of cooking time

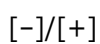



Setting time and cooking time.

With the “+” button, the time increases, with the “-” button the time decreases at a speed directly proportional to the length of time the button is pressed.



Setting a function

Select the desired function by pressing the corresponding button and set the time using the +/- buttons.



Appliance operation

At first control turning on, the display shows the flashing clock that increases by one unit every minute. Follow the “Setting the clock” procedure in the next paragraph. By pressing the  and  buttons simultaneously you enter the “Manual operation”. You can set the temperature using the thermostat knob (T) and select the function using the selector (S).

Setting the clock

The clock function is activated by simultaneously pressing  cooking duration  and end buttons. The time is then set by adjusting the +/- keys. Any previously set programs are automatically deleted.



Manual operation

To set this function simultaneously press the  cooking duration and  end buttons. The “A” symbol goes out and the pan symbol appears. The previously set programs are deleted.

INSTRUCTIONS FOR USE

– 5-button electronic programmer MP (Pro Line)



Semiautomatic operation with cooking duration

Select the duration function (button ) and set the time with the +/- buttons. The “A” symbol and the symbol  appear. The oven switches on. When the hour of the day coincides with the final time, viewable through the end of cooking button , the oven will turn off and the pan symbol will disappear. The buzzer will sound. The “A” symbol will flash.



Semiautomatic operation with end of cooking

Select the duration function (button ) and set the end time with the +/- buttons. The “A” symbol and the pan symbol appear. The oven switches on. When the hour of the day coincides with the final time the oven will turn off and the pan symbol will disappear. The buzzer will sound. The “A” symbol will flash.



Automatic operation with duration and end of cooking

Select the duration function , and set the end time with the +/- buttons. The “A” symbol appears. The oven switches on and the pan symbol  appears. Wait a few seconds until the current time appears. Set the end time by pressing the end of cooking button. The display shows an approximate end time. Use the +/- buttons to set the end time actually required. The oven switches off and the pan symbol  disappears. The pan symbol will appear again when the time of day coincides with the end time less the cooking time. At the end of the automatic program, the “A” symbol will flash. The buzzer will sound, the oven and the pan symbol will turn off.

Timer

Select the timer function (button ) and set the desired time with the +/- buttons. The bell  symbol will stay on while the set time is counting down. When the time comes to an end, the buzzer will sound.

Buzzer

The buzzer operates at the end of the cooking duration and timer function, and remains active for 7 minutes. The buzzer can be stopped by pressing any button   . The intensity of the buzzer can be changed by pressing the “-” button without selecting a function. You can choose from 3 different sound intensities and duration depends on the time pressure is exerted on the button “-”.

Starting a program and control

The selected program starts after the time has been set. The time remaining can be displayed at any time by selecting the corresponding function again.

Identifying a programming error

There is a programming error if the time shown by the clock is between the cooking start time and the cooking end time. The error is signaled by the buzzer sounding and by the intermittent flashing of the symbol “A”.

Cancellation of a program

The cancellation of a program is done by selecting the manual mode. At the end of the selected program, this will automatically cancel.

INSTRUCTIONS FOR USE

– 5-button electronic programmer E3/H3 (Nostalgie, Professional Plus)

Button legend



Set minute minder



Setting the cooking start time



Set end time cooking

[-]

Decreases the selected parameter

[+]

Increases the selected parameter







Display

F4-digit format, shows:



- In stand-by: the actual time.
- During manual cooking: the set temperature.
- During timed automatic cooking: the set temperature.
- During meat probe cooking: the probe's temperature.
- With timer on and oven in stand-by: the actual time.

Icons





- 1  Main oven icon [1]. If flashing the display shows the temperature and cooking duration settings of the main oven (only in the double oven)*
 - 2  Secondary oven icon [2]. If flashing the display shows the temperature and cooking duration settings of the secondary oven (only in the double oven).*
-  If lit the timer is on. If flashing it is over. Flashes while the timer is being set.
 -  If lit, the oven is working in delayed start mode. During the delayed start, it stays on.
 -  If lit, the oven is working in automatic end of cooking mode. It flashes during the delayed start mode, and then stays on when cooking is over.
 -  If lit, the clock is in 12-hour a.m. mode.
 -  If lit, the clock is in 12-hour p.m. mode.

(*) In the case of simultaneous use of ovens and to display the temperature and cooking time settings of the primary or secondary oven, press the corresponding thermostat knob.



INSTRUCTIONS FOR USE

– 5-button electronic programmer E3/H3 (Nostalgie, Professional Plus)

Appliance operation

At first control turning on, the display shows the flashing clock that increases by one unit every minute. The oven cannot operate and the possible operations to release it are: "Setting the clock" procedure through the [+] and [-] buttons or alternatively directly turning on the oven which involves the acceptance of the current clock value whatever it is. Detailed clock setting, timer, duration and end of cooking operations are indicated in the respective para-graphs below. Through the various setting buttons ( ,  , ) you enter the display and changing mode (indicated by a flashing display), in which [+] and [-] buttons are enabled to adjust the value shown on the display. This value is still accepted after 4 seconds from the last press of a button (the display remains lit). All settings are can be cancelled by pressing keys  and .



Setting the clock

Simultaneously press buttons  and  for 5" (the display flashes) and alter the time using the keys [+] and [-]. The clock can only be set with the oven on stand-by. The time display mode can be altered: during time setting by pressing the  button for 4 seconds; with the [+] button you can choose the 24 hours or 12 hours AM/PM option.

Turning the oven on and off

Turn selector [S]. The display shows "On". The light inside the oven comes on after two seconds and the display shows the default temperature expected from the selected cooking mode. To turn off during cooking, turn back the selector to [0], the display shows "OFF".



Timer

The function does not interact with the loads, and is available regardless of the oven's status. Press the button  : the bell symbol lights up and the display shows "0' 00". Set the time with [+] and [-], up to a maximum of 180 minutes, after 4 seconds without any increase or decrease the information is accepted, the bell remains on. By pressing the button  after changing the timer value it reverts to clock mode, having accepted the just altered value. Upon expiry of the set time a buzzer sounds together with the symbol  flashing. To stop the buzzer and the flashing, simply press any button.



Indefinite manual operation

Turn the oven on. Select a cooking function from those available. With knob [T] select the desired temperature. After 4 seconds after the last setting the oven operates for an indefinite time and the selected temperature remains on the display.

Semi-automatic end of cooking operation

Turn the oven on. Press button , the display shows "End". Set the end of cooking time with [+] and [-] buttons (the maximum cooking time is 10 hours). By pressing the button  after changing the duration value it reverts to clock mode, having accepted the just altered value. After 4 seconds from the last setting the oven is on for the set time. Having reached the programmed time you enter cooking finished mode.

Automatic operation

Turn the oven on. Press button  and select the cooking start time with [+] and [-] buttons. Press button , the display shows "End". Set the end of cooking time with [+] and [-] buttons. If no cooking time is selected, the oven remains in manual cooking mode indefinitely. After 4 seconds from the last setting the oven is on up to the specified time. You can always select a cooking function from those available and the temperature can be changed. Having reached the programmed time you enter cooking finished mode.

INSTRUCTIONS FOR USE

– 5-button electronic programmer E3/H3 (Nostalgie, Professional Plus)

Cooking over mode

At the end of timed cooking, the oven switches off all loads, a triple intermittent acoustic signal is activated of average intensity, the display shows "End", the cavity symbol flashes. To unlock the oven, simply press any of the programmer buttons: the acoustic signal ends and the oven is ready to receive new commands. This function is not available with the grill and fan grill cooking program.

Selezione temperatura di cottura

At the end of the cooking time, the oven switches off all loads, a triple intermittent buzzer of medium intensity sounds, the display shows the time, the cavity symbol flashes. To unlock the oven, simply press any button on the programmer: the buzzer ends and the oven is ready to receive new instructions.

Oven light control

The oven light remains on for 1 minute when the oven is turned on, and again for 1 minute at the end of preheating. Whilst waiting for a delayed start, the oven light is off. The oven light can always be turned on by pressing knob [T] and turns off automatically after 1 minute. During cooking, you can always leave the light on by pressing the knob [T] for 3 seconds.











Child safety lock

The oven is equipped with a safety device that prevents unwanted or accidental starting. To activate the safety: with oven off press and hold knob [T] for 3 seconds. A short beep sounds and the screen displays the symbol "n-0". In this situation it is impossible to start the oven. To remove the previously activated safety, keep knob [T] pressed for 3 seconds.

INSTRUCTIONS FOR USE

– 5-button electronic programmer E3

(Nostalgie, Professional Plus) – List of functions on electric multifunction oven

Pos.	Symbol	Function
1		<p>Pizza Cooking This function is particularly suitable for cooking pizzas, focaccias and bread. The main source of heat comes from the lower heating element which works in combination with the other furnace resistances.</p>
2		<p>Normal static cooking It is the classic function of the electric oven particularly suitable for cooking the following foods: pork chop, sausages, cod, braised meat, game, roast veal, meringues and biscuits, baked fruit, etc.</p>
3		<p>Cooking from below This is the best cooking to finish cooking food, especially pastry (biscuits, meringues, leavened cakes, fruit desserts, etc.) and other foods.</p>
4		<p>Cooking from above Particularly suitable for browning and to give the final touch of color to many foods; it is the recommended function for hamburgers, pork chops, veal steaks, sole, cuttlefish, etc.</p>
5		<p>Grill cooking with closed door The function indicated for quick and deep grilling, for grilling and roasting meat in general, fillet, Florentine steak, grilled fish and even grilled vegetables. Cooking with the electric grill must be carried out with the thermostat at 180 ° C.</p>
6		<p>Ventilated grill cooking Particularly fast and deep with considerable energy savings, this function is suitable for many foods such as: pork chop, sausages, pork or mixed skewers, game, Roman-style gnocchi, etc. Cooking with the electric grill must be carried out with the thermostat at 180 ° C.</p>
7		<p>Intensive cooking It is the function of the rapid and intense cooking of various dishes; suitable for: baked fish, braised vegetables, skewers, duck, chicken, etc.</p>
8		<p>Multiple ventilated cooking It is the function that allows the simultaneous cooking of different dishes without the smells mixing together; you can cook baked lasagna, pizza, croissants and croissants, pies, cakes, etc.</p>
8a		<p>Eco cooking It is the function that allows you to cook with a considerable saving on electricity consumption. To make the most of it this feature is useful, before inserting the ECO function, introduce the dish inside the oven placing it in the center of the cavity. With the Eco function, cooking times adapt to slow cooking such as: braised meat, white meat, baked pasta, delicate pastry. This cooking cycle is not recommended for frozen foods. To select Eco cooking turn the selector knob "S" to position 8 and then, when the display shows "ON", hold down the "+" key of the programmer for about 2 seconds until the appearance on the display of the word "ECO". With Eco cooking the programmable temperature goes from a minimum of 30 ° C up to a maximum of 300 ° C. Note: Eco cooking cannot be selected with the meat probe inserted.</p>
9		<p>Quick Start (only available for some models) This function is used to speed up the preheating of your oven. We suggest you use this function when setting a cooking temperature between 200° and 300° C. Using the QuickStart function for temperatures below 200° C does not offer particular advantages. To use the Quick Start function, turn the selector knob (S) until it is positioned on the symbol (9), then set the desired temperature with the thermostat knob (T). Once the oven has reached the temperature, the orange thermostat light goes off and the oven is ready to receive the food to be cooked. At this point, set the desired cooking function. CAUTION: the Quick Start function is not suited to cooking food, it only serves to preheat the oven more quickly. DO NOT USE THE QUICK START FUNCTION FOR MORE THAN 20 MINUTES.</p>

INSTRUCTIONS FOR USE

– 5-button electronic programmer E3/H3 (Nostalgie, Professional Plus)

Cooking inspection

If you need to inspect the food being cooked, you can open the oven door. In this case the lights come on and the cooking process stops. Closing the door reactivates the previously set function.

Dry/moist cooking

The oven has an automatic device which allows steam from cooking, in some functions, to be expelled from the oven: this is dry cooking (dry). If the cooking requires that the moisture remains inside the oven, moist cooking (moisture), the automatic device can be switched off as follows:

after selecting the desired cooking function, when **[ON]** appears on the display hold down the “-” programmer button for about 2 seconds until **[HUM]** appears on the display. This involves a choice that allows you to modify dry cooking with moist cooking to your liking.

The functions concerned are:



Cooking with probe (only available on some models)

N.B. Cooking with probe cannot be used in the “**DEFROST**”, “**QUICK START**”, “**PIZZA**” and “**ECO**” functions. When the oven is in stand-by insert the meat probe into the connecting socket on the left hand wall of the oven: the clock displays “**MEAT**” for 2 seconds and the “probe” symbol flashes. Next the probe’s default temperature(75°C) appears on the display. By turning and then pressing the adjustment button, select the end of cooking temperature from the 2 limit values of 40° and 100°C (the food’s internal temperature). After 4 seconds from the last setting, the set value is memorized and the probe symbol stays on. Turn on the oven, select the cooking function and the desired temperature using the appropriate knobs. The display will show the probe’s temperature reading.

Upon reaching the programmed temperature the oven will turn off, a buzzer sounds and the display shows the message “**End**” and you enter the cooking over mode.

During cooking it is always possible to change the probe’s temperature by pressing and then turning the adjustment knob 3 times.

NOTE: If you insert the probe into the special socket during cooking, the oven will turn off and “**Off**” appears on the display.

If, during cooking, the probe is removed from the special socket, the oven will turn off and “**Off**” appears on the display.

INSTRUCTIONS FOR USE

– 5-button electronic programmer E3

(Nostalgie, Professional Plus) – List of functions on static electric oven



Upper & lower elements

Is the classical function of the electric oven and particularly adapted for cooking: pork chops, sausages, dried salt-cured cod, pot roast, game, roast veal, meringues and biscuits, baked fruit, etc.



Lower element

This setting is most suitable for finishing cooking, particularly pastries (biscuits, meringues, desserts, puff pastry, fruit cakes, etc.) and other foods.



Upper element

Especially suitable for browning and to add the finishing touches of colour to different dishes. We suggest this setting when cooking hamburgers, pork cutlets, steaks, sole, cuttlefish, etc.



Grill-baking

A suitable setting for grilling au gratin and roasting quickly and well, meat in general, fillet, T-bone steak, grilled fish and vegetables too. Cooking by electric grill must be done with the thermostat set at 180°C.



Eco cooking

It is the function that allows you to cook with a considerable saving on electricity consumption. To make the most of it this feature is useful, before inserting the ECO function, introduce the dish inside the oven placing it in the center of the cavity. With the Eco function, cooking times adapt to slow cooking such as: braised meat, white meat, baked pasta, delicate pastry. This cooking cycle is not recommended for frozen foods.

To select Eco cooking turn the selector knob "S" to position 1 and then, when the display shows "ON", hold down the "+" key of the programmer for about 2 seconds until the appearance on the display of the word "ECO". With Eco cooking the programmable temperature goes from a minimum of 30 ° C up to a maximum of 250 ° C.

IINSTRUCTIONS FOR USE

– 5-button electronic programmer H3

(Nostalgie, Professional Plus) – Functions list H3

S. Selector

T. Thermostat

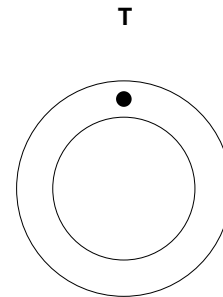
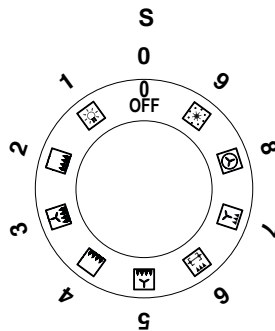

Pos./Pr.	Symbol	Function
1/PR1		<p>Light oven</p> <p>With this function it comes only turned on the inside light of the oven in permanent way without activating any other load. The light of the oven remains turned on for 1 minute when:</p> <ul style="list-style-type: none"> • the desired function is selected; • when the oven reaches the temperature previously planned; • when the handle grip of the thermostat is pressed; • when the key is pressed + (full touch); • when, to out frono, you/he/she is opened the door; After 1 minute the light automatically extinguishes him.
2/PR2		<p>Cooking from under (burner gas)</p> <p>It is the function of the rapid and intense cooking of various dishes; it is suitable for: fish to the bag, braised vegetables, skewers, duck, chicken, etc. You programmable maximum temperature is of 300 °Cs. To optimize the cooking he advises to position the dish in the center of the oven (third position). Note: when the oven is switched on for the first time, it starts for 10 seconds, remains off for the next 15 seconds and then re-starts up to the set temperature.</p>
3/PR3		<p>Ventilated (burner gas + radial ventilation) cooking</p> <p>It is the function that allows the simultaneous cooking of different dishes without the odors mix him among them. The forced circulation of the warm air inside the room of cooking assures a uniform division of the heat. Lasagnas can be cooked to the oven, pizza, croissant and brioches, tarts, cakes, etc. You programmable maximum temperature is of 250° Cs. Note: when the oven is switched on for the first time, it starts for 10 seconds, remains off for the next 15 seconds and then re-starts up to the set temperature.</p>
4/PR4		<p>Cooking from under SOFT (burner gas)</p> <p>It is the particularly suitable function for the cooking of delicate foods as sweets and confectionery. The correct combining between programmed temperature and time of cooking avoids with this function to burn the foods. And' fundamental, before beginning the cooking to preheat the oven to the desired temperature. The programmable maximum temperature is of 200 °Cs. To optimize the cooking he advises to position the dish in the center of the oven (third position). Note: when the oven is switched on for the first time, it starts for 10 seconds, remains off for the next 15 seconds and then re-starts up to the set temperature.</p>
5/PR5		<p>Ventilated cooking SOFT (burner gas + radial ventilation)</p> <p>It is the particularly suitable function for the simultaneous cooking of particularly delicate foods without the odors mix him among them. The correct combining between programmed temperature and time of cooking avoids with this function to burn the foods. The forced circulation of the warm air inside the room of cooking assures an uniform division of the heat it is' fundamental, before beginning the cooking to preheat the oven to the desired temperature. The programmable maximum temperature is of 200 °Cs. Note: when the oven is switched on for the first time, it starts for 10 seconds, remains off for the next 15 seconds and then re-starts up to the set temperature</p>
6/PR6		<p>Cooking grill to closed door</p> <p>It is the suitable function for the cooking to the fast and deep grate, for gratinare and to generally roast the meats, read fi, tart to the fi orentina, fish to the grate and also vegetables to the grate. The maximum programmable temperature is 230° C.</p>

IINSTRUCTIONS FOR USE

– 5-button electronic programmer E3/H3

(Nostalgie, Professional Plus) – Functions list gas oven H3



Cooking ventilated grill

Particularly fast and deep with notable energy saving, this function is suitable for many foods what: cutlet of pig, sausages, skewers of pig or mixed, game, potato dumplings to the Roman, etc.
The maximum programmable temperature is 230° C.



Cooking ventilated multiple

And' the function that allows to contemporarily perform different cookings without the odors mix him among them maintaining unchanged the taste of every dish. The forced circulation of the warm air inside the room of cooking assures an uniform division of the heat. Lasagnas can be cooked to the oven, pizza, croissant and brioches, tarts, cakes, etc. You programmable maximum temperature is of 250 °Cs.



Unfreezing

It allows the rapid defrosting of all the foods generally frozen that you/they are quickly brought environment to the temperature. The programmable maximum temperature is of 60° Cs.

Indicator lights

There are 2 indicator lights on the panel:

- **orange indicator light:** if lit, it indicates the presence of a flame on the gas burner of the oven. It switches off when the oven centre's temperature reaches the programmed temperature value.
- **green indicator light:** if lit, it indicates that the electric heaters are on. It switches off when the oven centre's temperature reaches the programmed temperature value.

INSTRUCTIONS FOR USE

– Gas oven H3

Safety



Keep children far from the appliance during the operation. The safety norms are not always able to cover every type of accident. Don't use the appliance as a source of heating.

General notes

To maintain the appliance efficient and sure, maintenance must be submitted to specialized technicians or to the personnel of the service assistance in guarantee. Clean the oven after every use. Dirt is easily cleaned to avoid that it burns to higher temperatures. Choose based on the quantity of food to cook some containers resistant to heat.

First use

Remove all the removable parts from the oven, wash them with some cleanser, therefore reassemble them. Turn on the oven for about 30 minutes bringing the thermostat to 230°C leaving the exchange of air opened. The unpleasant odor that derives is inevitable. After the oven cooled down, clean it following the instructions of the paragraph "Cleaning and care."

Recommendations on the gas cooking

The cooking performed with the gas oven, compared to a traditional electric oven, has the property to maintain the dish softer. During the combustion, in fact, it is emitted some aqueous vapor. The same vapor passes through the cooking room before being expelled together with the gases of combustion, making the cooking environment damp, and avoiding that inside the dishes water evaporates too much. The formation of condensates on the inside glass of the door after the lighting of the oven confirms the phenomenon just described (with the increase in temperature the inside glass of the door cleans from the condensates). For cooking at lower temperatures than 200°C, it is recommended to always use the functions "Cooking from under SOFT" and "ventilated Cooking SOFT".

How to use the gas oven

Choose one of the 9 cooking functions rotating the selector (S) and select the temperature (from 30°C to 300 °C) with the thermostat (T).

Attention: before beginning to cook it is recommended to always preheat the oven: after having selected the function and the desired temperature before baking the dish attend the turning off of the spy of the thermostat accompanied by the lighting of the light inside the oven.

Function



In all the functions (gas and electric) it is anticipated the contemporary starting of the motor of tangential cooling, useful to cool the components and to avoid that the vapor, during the cooking, is deposited on the glass of the door. With the oven turned off, if the internal temperature is still high, the motor of tangential cooling will continue to work automatically.

Attention



















The burner flame lights automatically through a particular electronic flame control device. If the flame does not remain on after the 5" light-up time, the system stops and the orange light starts to flash. To reset the system, simply turn off the oven and repeat the light-up procedure.

INSTRUCTIONS FOR USE

– Display TFT touch (Majestic)

– Icon legend

	Break		Home
	Start		Light
	°C - °F		Timer
	Screen lock		Exit - Terminate
	Settings		Clock
	Settings		Confirm Settings
	Meat probe		Switch off
	Flame presence		Knob present in some models. (It allows to set and confirm the functions of the TFT in addition to the Touch display)

INSTRUCTIONS FOR USE

– Display TFT touch (Majestic)

– Settings

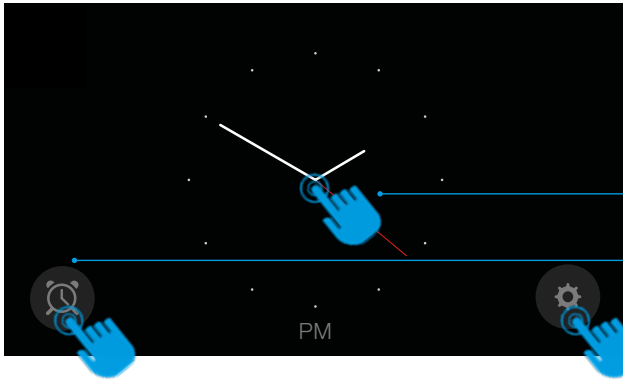

Home: display homepage.

3 options

Allows you to proceed to the screen setting of the cavity

Allows you to set the timer

Gives you direct access to the settings

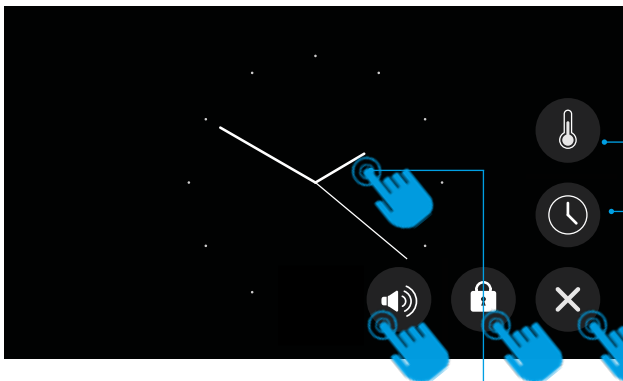

Settings

Choice of degree scale (°C or °F).

Time settings.

Exit the settings page.

Allows you to lock the screen.

Allows you to set the volume of the beep and choose a sound when touching the display

To unlock touch on the display for 10 seconds

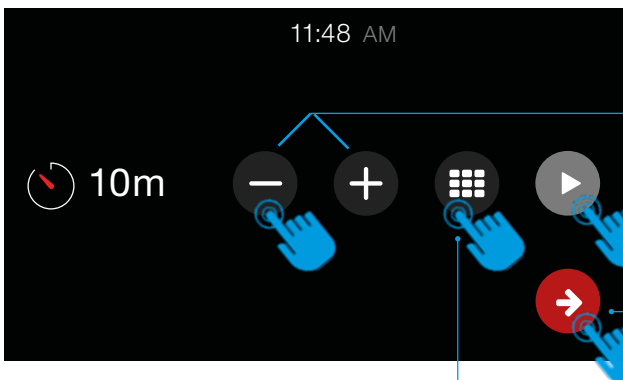

Setting a timer

Increase or decrease the time.

Confirm once you have set the desired time. An audible signal will indicate the end.

Confirm and return to the home page.

Numeric keyboard

INSTRUCTIONS FOR USE

– Mod. oven E3 - H3 - static with TFT touch (Majestic)

– Cooking function setting

1- Choose the cooking function

Light (on or off)

Home (Return to home page)

2- Set the cooking temperature

2a - There are two options for setting the temperature:
 - Scrolling the bar
 - With + or -

2b - Conferma la funzione di cottura

3- 3- Set the cooking time and the programmed start

4- Cavity selection (only for multiple cavity models)

3a - Set the cooking time

3b - Shows the time of the cooking time

3c - Set the start time

3d - Confirm the cooking function

1a - Choose dry/wet cooking

1b - Confirm the cooking function

NOTA: Possible only in certain cooking modes

INSTRUCTIONS FOR USE

– Mod. oven E3 - H3 - static with TFT touch (Majestic)

– Cooking process

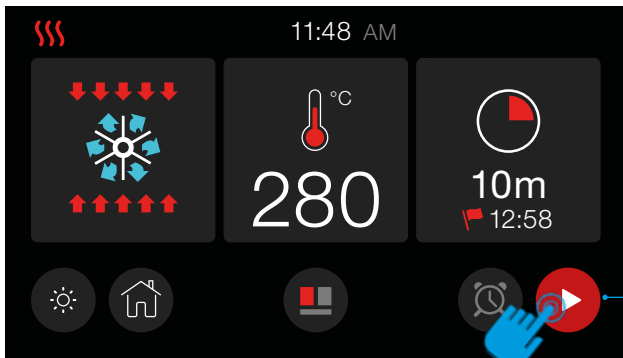

CAVITY SET

Once the cavity has been set (cooking function, temperature and timer), confirm to start the preheating. At this point the display will switch to the preheating mode

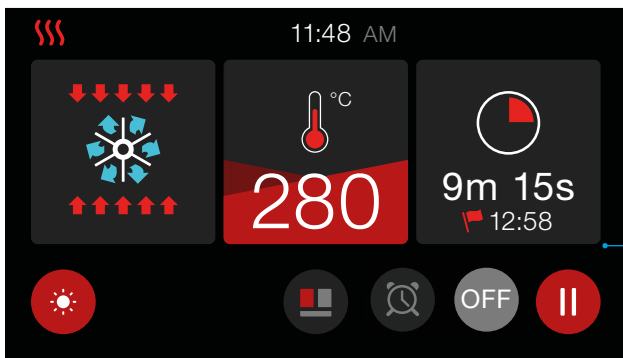

PREHEATING PHASE

There are four levels that allow you to monitor the preheating process. The red part will gradually increase to fill the display.

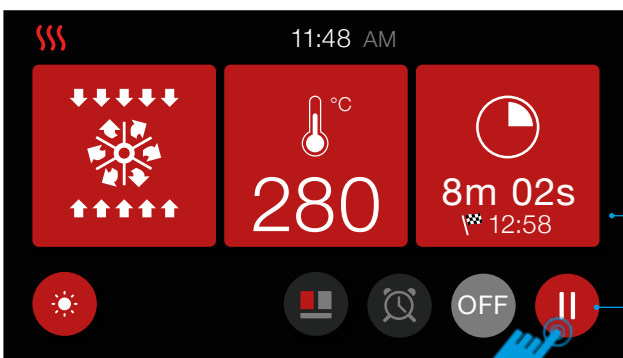

PREHEATING TERMINATED

When the set temperature is reached, the display will turn red to indicate the end of the preheating phase, and the start of the cooking phase. If a cooking time has been set, the oven will automatically switch off at the end of the time.

In case of no set cooking time it is possible to suspend the cooking



and then finish it

AND THEN FINISH IT

N.B. Cooking with probe cannot be used in the “DEFROST”, “QUICK START”, “PIZZA” and “ECO” functions. When the oven is in stand-by insert the meat probe into the connecting socket on the left hand wall of the oven

PROBE TEMPERATURE SELECTOR

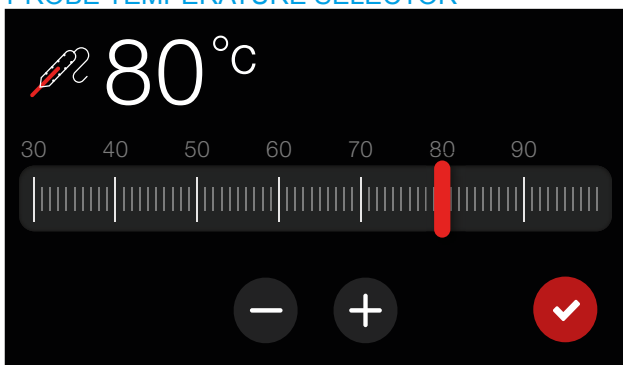

PREHEATING MODE WITH MEAT PROBE

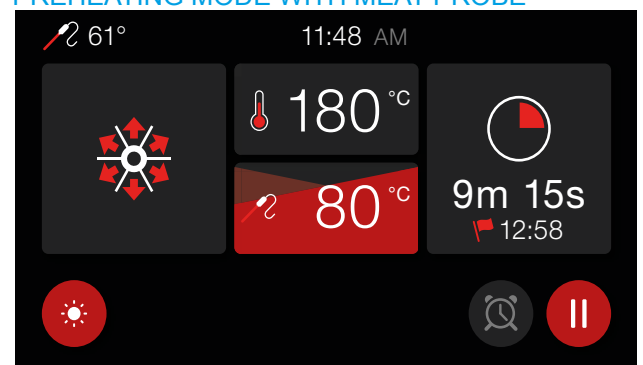

ATTENTION: if the display does not respond to the commands (touch locked), simply open and close the oven door

INSTRUCTIONS FOR USE

– Mod. oven E3 with TFT touch (Majestic)

– Functions list



Pizza cooking

This function is particularly suitable for cooking pizza, focaccia and bread. The main source of heat is from the bottom heating element that works in combination with the oven's other resistances.



Normal static cooking

It is the oven's classic function particularly suited to cooking the following foods: pork chops, sausages, cod, braised beef, game, roast veal, meringues and biscuits, baked fruit, etc.



Cooking from underneath

This is the most suitable mode to finish the food cooking, in particular confectionery (biscuits, meringues, leavened cakes, fruit desserts, etc.) and other foods.



Cooking from above

Especially suitable for browning and to give the final touch of colour to many foods; it is recommended for ham- burgers, pork chops, veal steaks, sole, cuttlefish, etc.



Closed door grill cooking

The suitable function for fast and deep grilling, to brown and roast meats in general, fillet steaks, Florentine steaks, grilled fish and also grilled vegetables. Cooking with the electric grill must be made with the thermostat at 180 °C.



Fan grill cooking

Particularly fast and deep with significant energy savings, this function is suitable for many foods such as pork chops, sausages, pork or mixed spits, game, gnocchi alla romana, etc. Cooking with the electric grill must be made with the thermostat at 180 °C.



Intensive cooking

Is the quick and intense cooking function for various dishes; best for: baked fish, braised vegetables, spits, duck, chicken, etc.



Multiple fan cooking

It is the function that allows simultaneous cooking of different dishes without the smells blending; you can cook lasagne, pizza, croissants and brioches, tarts, cakes, etc.



Eco cooking:

Is the function that allows you to cook with considerable energy savings. To take advantage of this feature, place the dish in the centre of the oven before starting the ECO function. With the ECO function, cooking times can be adapted to slow cooking as: braised meats, white meats, baked pasta, delicate pastry. This cooking cycle is not recommended for frozen food.

This cooking cycle is not recommended for frozen foods.

Note: Eco cooking cannot be selected with the meat probe inserted.



Unfreezing

It allows the rapid defrosting of all the foods generally frozen that you/they are quickly brought environment to the temperature.



Dry/wet Cooking

The oven is equipped with an automatic device that allows the condensation vapours of the firings, in some functions, to be expelled from the oven: This involves dry cooking (dry). Should the need for cooking require that moisture remain inside the oven, moist cooking (moisture) the automatic device can be switched off by touching the appropriate icon.



Quick Start (only available for some models)

This function is used to speed up the preheating of your oven. We suggest you use this function when setting a cooking temperature between 200 and 320° C. Using the QuickStart function for temperatures below 200° C does not offer particular advantages.

To use the Quick Start function, turn the selector knob (S) until it is positioned on the symbol (9), then set the desired temperature with the thermostat knob (T). Once the oven has reached the temperature, the orange thermostat light goes off and the oven is ready to receive the food to be cooked. At this point, set the desired cooking function.

CAUTION: the Quick Start function is not suited to cooking food, it only serves to preheat the oven more quickly.

DO NOT USE THE QUICK START FUNCTION FOR MORE THAN 20 MINUTES.

Cooking

If you need to inspect the food in cooking you can open the oven door. In this case the lights are lit and the forced ventilation is stopped, in the case of ventilated cooking, and the rotation of the spit, in the case of grill cooking with closed door. Closing the door reactivates the previously set function.

INSTRUCTION FOR USE

– Mod. oven H3 with TFT touch (Majestic)

– Functions list



Cooking from under (burner gas)

It is the function of the rapid and intense cooking of various dishes; it is suitable for: fish to the bag, braised vegetables, skewers, duck, chicken, etc. You programmable maximum temperature is of 300 °Cs. **To optimize the cooking he advises to position the dish in the center of the oven (third position). Note: when the oven is switched on for the first time, it starts for 10 seconds, remains off for the next 15 seconds and then re-starts up to the set temperature.**



Ventilated (burner gas + radial ventilation) cooking

It is the function that allows the simultaneous cooking of different dishes without the odors mix him among them. The forced circulation of the warm air inside the room of cooking assures an uniform division of the heat. Lasagnas can be cooked to the oven, pizza, croissant and brioches, tarts, cakes, etc. You programmable maximum temperature is of 250° Cs. **Note: when the oven is switched on for the first time, it starts for 10 seconds, remains off for the next 15 seconds and then re-starts up to the set temperature.**



Cooking from under SOFT (burner gas)

It is the particularly suitable function for the cooking of delicate foods as sweets and confectionery. The correct combining between programmed temperature and time of cooking avoids with this function to burn the foods. And' fundamental, before beginning the cooking to preheat the oven to the desired temperature. The programmable maximum temperature is of 200 °Cs. To optimize the cooking he advises to position the dish in the center of the oven (third position). **Note: when the oven is switched on for the first time, it starts for 10 seconds, remains off for the next 15 seconds and then re-starts up to the set temperature.**



Ventilated cooking SOFT (burner gas + radial ventilation)

It is the particularly suitable function for the simultaneous cooking of particularly delicate foods without the odors mix him among them. The correct combining between programmed temperature and time of cooking avoids with this function to burn the foods. The forced circulation of the warm air inside the room of cooking assures an uniform division of the heat it is' fundamental, before beginning the cooking to preheat the oven to the desired temperature. The programmable maximum temperature is of 200 °Cs. **Note: when the oven is switched on for the first time, it starts for 10 seconds, remains off for the next 15 seconds and then re-starts up to the set temperature.**



Cooking grill to closed door

It is the suitable function for the cooking to the fast and deep grate, for gratinare and to generally roast the meats, read fi, tart to the fi orentina, fish to the grate and also vegetables to the grate. Use of the grill and roaster (only on some models): to support the auction of the spit on the special support and infi lara in the moped of the roaster. Ideal for chicken to the spit, skewers, etc. The maximum programmable temperature is 230° C.



Cooking ventilated grill

Particularly fast and deep with notable energy saving, this function is suitable for many foods what: cutlet of pig, sausages, skewers of pig or mixed, game, potato dumplings to the Roman, etc. The maximum programmable temperature is 230° C.



Cooking ventilated multiple

And' the function that allows to contemporarily perform different cookings without the odors mix him among them maintaining unchanged the taste of every dish. The forced circulation of the warm air inside the room of cooking assures an uniform division of the heat. Lasagnas can be cooked to the oven, pizza, croissant and brioches, tarts, cakes, etc. You programmable maximum temperature is of 250 °Cs.



Unfreezing

It allows the rapid defrosting of all the foods generally frozen that you/they are quickly brought environment to the temperature.



Flame presence

When using a gas function, the "flame presence" symbol appears on the display, in particular:



- it indicates the presence of a flame on the oven's GAS burner during cooking or during preheating



- it indicates that the programmed temperature has been reached in the oven's centre



- it indicates that the light-up system is blocked. To reset cooking, simply touch the start button

Cooking

If you need to inspect the food in cooking you can open the oven door. In this case the lights are lit and the forced ventilation is stopped, in the case of ventilated cooking, and the rotation of the spit, in the case of grill cooking with closed door. Closing the door reactivates the previously set function.

INSTRUCTIONS FOR USE

– Mod. oven static with TFT touch (Majestic)

– Functions list



Upper & lower elements

Is the classical function of the electric oven and particularly adapted for cooking: pork chops, sausages, dried salt-cured cod, pot roast, game, roast veal, meringues and biscuits, baked fruit, etc.



Lower element

This setting is most suitable for finishing cooking, particularly pastries (biscuits, meringues, desserts, puff pastry, fruit cakes, etc.) and other foods.



Upper element

Especially suitable for browning and to add the finishing touches of colour to different dishes. We suggest this setting when cooking hamburgers, pork cutlets, steaks, sole, cuttlefish, etc.



Grill-baking

A suitable setting for grilling au gratin and roasting quickly and well, meat in general, fillet, T-bone steak, grilled fish and vegetables too. Cooking by electric grill must be done with the thermostat set at 180°C.



Eco cooking:

Is the function that allows you to cook with considerable energy savings. To take advantage of this feature, place the dish in the centre of the oven before starting the ECO function. With the ECO function, cooking times can be adapted to slow cooking as: braised meats, white meats, baked pasta, delicate pastry. This cooking cycle is not recommended for frozen food.

INSTRUCTIONS FOR USE

– Accessories

turn-spit
(only on some models)

Slide the meat to be cooked onto the spit, blocking it with the special forks. Place the spit on the special supports previously inserted in the drip pan and insert it in the spit-roast horn. Turn on the static grill with closed door function. To extract the spit together with the drip pan pull it out just enough to allow complete extraction.



Telescopic runners
(only in certain models)

This solution has been studied to increase the ergonomics, the practice and safety when moving baking trays in the oven. The kit includes completely extendible lateral runners, which slide on ball bearings to facilitate the removal and positioning of the trays. The runners are anti tip-over for better safety. It is possible to remove them to clean them or move them as illustrated in the pictures below.

Pul down the part highlighted in red to remove it from the oven.

Turn over the grill and place it on a flat surface whit the telescopic runner facing down.

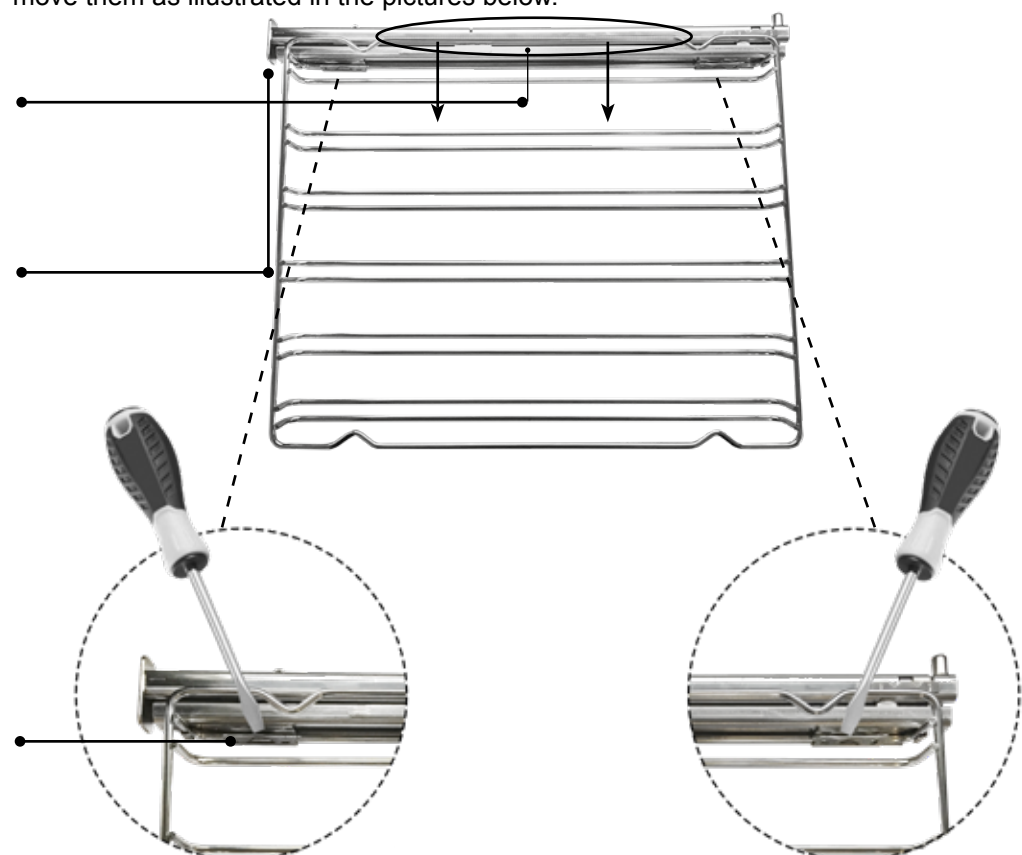

To un nook the clip, loosen whit a flathead screwdriver

Repeat the operations backwards to repositions the grills.

CLEANING AND MAINTENANCE

– Replacing the bulb

Procedure to follow

Should the oven light not work, disconnect the appliance from the mains, remove the lamp protection glass and replace the bulb. The new bulb must, naturally, be suitable for use at high temperatures and has the characteristics for such use.

1

Losen whit a flathead screwdriver

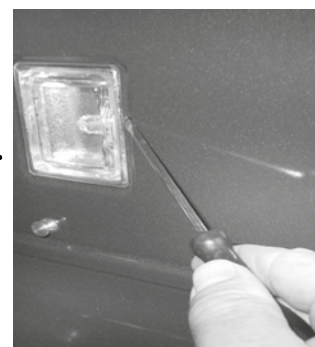

2

Remove the glass cover

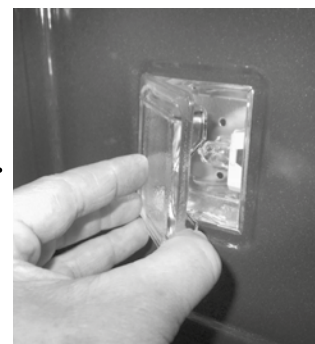

3

Pull out the light

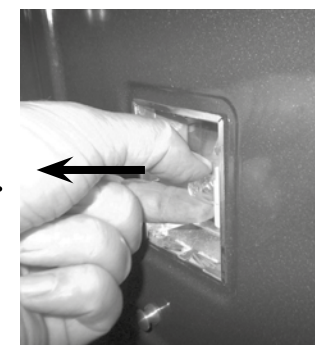

4

Replace and close again

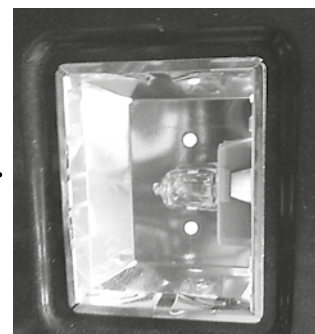

CLEANING AND MAINTENANCE

– Door removal

Procedure to follow

For ease of intensive cleaning it is practical to dismantle the door following these instructions:

- open the door
- move the hook **C** to the hinge zone **D**, following the steps

1



2



3



4

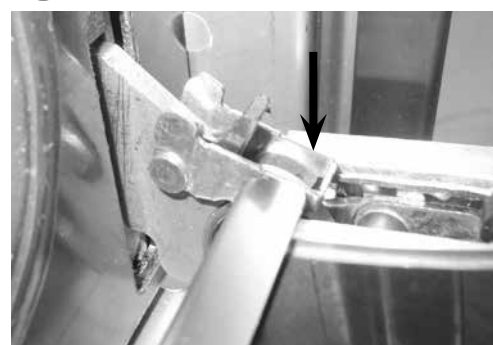

5 (only on some models)



6



CLEANING AND MAINTENANCE

– Cleaning the door and glasses

Procedure to follow

The oven door is composed of 3 sheets of plate glass (two in some cases). The plate glass parts may be cleaned using absorbent kitchen paper and an ordinary non-abrasive detergent. Do not use coarse abrasive cleaning materials or sharp metal scrapers to clean the oven's glass doors since they can scratch the surface and cause the glass to shatter

The inside glass may be removed to facilitate cleaning. To do this it is necessary to dismantle the oven door or, alternatively, to set it in the intermediate click position.

Sequence for removing the glasses



ATTENTION! every procedure must be done with the door removed and placed on an adequate surface in order to not damage the door's facade.

1

Unscrew the 2 screw on/the sides in the upper baton



2

Lift the upper glass and pull it out



3

Pull out the middle glass

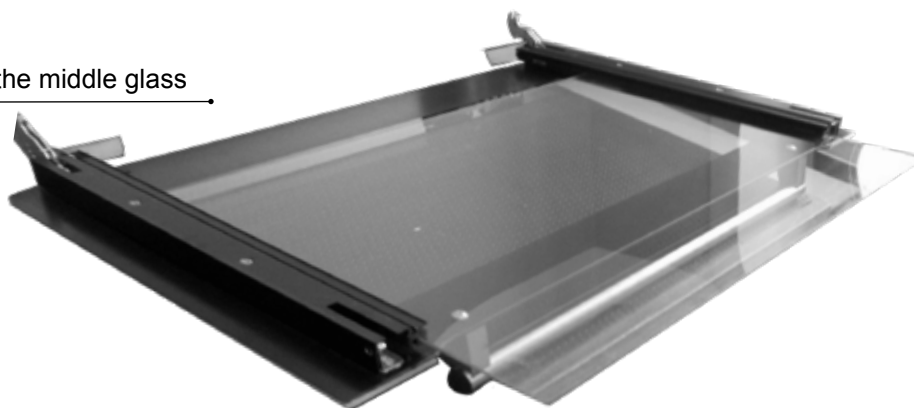

CLEANING AND MAINTENANCE

– Recommendations for cleaning the cooktop

ATTENTION:



Before carrying out any cleaning operations, disconnect the appliance from the mains and close the gas valve. The cooktop must be cleaned after it has been let cooling down.

COOKTOP

COMPONENT	CLEANING METHOD	WARNINGS
Steel surfaces	Clean the details with warm water and non-abrasive detergent. Dry with a soft microfiber cloth.	Brilliance is maintained through regular cleaning with specific products which can be found in commerce. Never use abrasive powders.
Enameled surfaces	To maintain the characteristics of the enameled surfaces it is necessary to regularly clean them with soapy water.	Avoid leaving acidic or alkaline substances (vinegar, lemon juice, salt, tomato juice, etc.) on enameled parts and washing them when are still hot.
Cooktop grills	Remove the grills and wash them with warm water and non-abrasive detergent. Carefully remove every encrustation. Dry before placing them back on the cooktop.	Acidic substances such as lemon juice or other acidic detergents may permanently damage the enamel of the grills. Carefully dry the grills with a cloth right after the cleansing. It is not recommended to wash them in the washing machine.
Spark plugs and thermocouples	Clean with a humid cloth. If necessary, remove dry dirt with a toothpick or a needle.	Spark plugs and thermocouples must be cleaned and checked regularly.
Crowns, gas rings, and caps	Gas rings and caps are removable to allow easy cleaning. Wash them with hot water and non-abrasive detergent.	Carefully remove every encrustation and wait that they are completely dried off. In the case of malfunctioning, make sure that the holes in the external crown are always perfectly cleaned.
Induction or fiberglass	Remove light stains with a humid cloth and dry with a soft cloth.	Don't clean with abrasive products. Don't use any object that could ruin the fiberglass top. Make sure that the bottom of the pan is dry and clean, and that glass surface has no dust. Moving the pan may scratch the glass. Immediately remove residual sugar, jam and jelly to prevent damaging the glass.

CLEANING AND MAINTENANCE

– Recommendations for cleaning the oven and the front panel

OVEN

COMPONENT	CLEANING METHOD	WARNINGS
Oven inside	It is recommended to clean the oven after every use. Dirt is cleaned more easily avoiding to let it burn several times at high temperatures. Remove every removable part and clean it separately with hot water and non-abrasive detergent. The cavity is cleaned with a soft cloth soaked with a solution made of water and ammonia. Rinse and dry.	Do not use vapor cleaner to clean the interior of the oven. Do not use abrasive/corrosive detergents or sharp tools to clean the glass of the door as they could damage and break the surface.
Tray	Immerse in a solution made of water and neutral soap. Dry afterwards.	Remove residual food immediately after use.
Grills	Clean with warm water and non-abrasive detergents or with a suitable degreaser.	In case of encrusted and hardened dirt, we recommend soaking the grills for a few hours before cleaning them.

FRONT PANEL

COMPONENT	CLEANING METHOD	WARNINGS
Steel surfaces	Clean the parts with lukewarm water and non-corrosive liquid detergent and then dry them with a soft cloth or microfiber.	Brilliance is maintained through regular cleaning with specific products which can be found in commerce. Never use abrasive powders
Painted surfaces	To maintain the characteristics of the painted parts, it is necessary to frequently clean them with soapy water.	Avoid leaving acid or alkaline substances on the painted parts (vinegar, lemon juice, salt, tomato juice, etc.) and washing when the painted parts are still hot.

CLEANING AND MAINTENANCE

– Maintenance and cleaning of total black burners with nanotechnological coating

ATTENTION!



Some cleaning and washing methods are recommended in order to preserve the quality of the coating.

- Allow the product to cool down at room temperature before cleaning it. It is recommended not to dip it in cold water when it is still hot.
- Wash with warm water and a minimum of neutral detergent. Rub with a cloth, better if in natural cellulose, or non-abrasive sponge.
- Do not use dust, iron wool, cloths and abrasive sponges.
- Do not let food be charred on the burner. In case stains/colorations may appear on the surface. These traces do not alter the functionality of the product, and in some cases can be eliminated with this procedure: immerse the product in hot water, with detergent, wipe gently with a cloth, better if in natural cellulose; in any case, do not use abrasive cloths or sponges. For the most resistant stains, it is advisable to warm white vinegar and rub as indicated above.
- Avoid leaving the burners in contact with food for a long time, especially if acidic, such as tomato sauce.
- Avoid contact with metal objects; if really needed, use wooden or plastic objects.
- Avoid washing in the dishwasher, a part of the product is not coated and would get irreparably damaged.
- In case of malfunction, make sure that the holes in the outer crown are perfectly clean.

PROBLEM SOLVING

– Guide for the resolution

ATTENTION:

- During the guarantee period repairs can only be carried out by the authorized after-sales service.
- Before repairing, unplug the appliance from the power supply, that is, unplug the power cable or use the appropriate switch.
- Unauthorized interventions and repairs can cause electrocution or short circuit, therefore do not carry them out. Leave these works to authorized technicians.
- In case of small disturbances, it is possible to solve the problem following the instructions.
- After-sales service intervention during the guarantee period is not free, if the appliance does not work because of incorrect use.
- The elimination of the faults or complaints, caused by incorrect use or installation, will not be repaired under guarantee. In such cases, the repair costs will be borne by the user

Small solvable problems without the help of a skilled technician

Problem	Causes	Elimination
The flame is uneven / unstable.	Wrong gas setting	Have an expert check the gas setting
The flame from the burners suddenly changes	Wrongly assembled burner parts	Assemble the burner correctly
The flame from the burners suddenly changes	Wrongly assembled burner parts	Assemble the burner correctly
Burner ignition takes more time	Knob pressed for too short a time or too delicately	Keep the knob depressed longer. Before releasing it, press it harder
The flame is extinguished shortly after ignition	This is a commonplace phenomenon resulting from high temperatures	Clean the grid with a metal-care detergent
The grill has burner area in the discoloured	The igniter or terminal block may be damaged	Check block igniter and/or and replace if terminal damaged
Electric power supply in general is uneven	There are food or detergent residues between the igniter electrode and the burner	Carefully clean between the igniter electrode and the burner
The burner covers are dirty	Regular dirt	Clean the burner covers with a metal care detergent.
The display does not respond to commands	Display touch control blocked	Open and close the oven door

PROBLEM SOLVING

– Induction hob malfunction

Anomaly

Causes

The appliance and the hob do not switch on

- The hob has not been properly connected to the electrical network.
- The protection fuse is broken
- Activates the key-lock function.

The “U” symbol appears on the display

- The pot was not placed on the cooking zone.
- The pot is not compatible with induction.
- The diameter of the bottom of the pot is too small.

The “**E**” symbol appears on the display

- The safety system is in operation.
- The pot is not compatible with induction.
- The diameter of the bottom of the pot is too small.

The cooking zones do not work

- The safety system is in operation.
- The pot is empty and the bottom has overheated.

If ventilation remains on when the hob is switched off

- This is not a malfunction. The ventilator continues to function to protect and cool down the electronics.
- The automatic ventilation will stop automatically.

PROBLEM SOLVING

– TFT display errors

System errors

The following errors are detected:
The error code syntax is: “E YY X”, where:

YY = error code
x = cavity number when error occurred or ‘ 0 ’ for general errors

Description	Error ID
Cavity probe in open circuit	00
Cavity probe in short circuit	01
Meat probe in open circuit	04
Meat probe in short circuit	05
Overheating	08
Tangential fan not working	16
Incorrect mapping card	19
Communication error	20

ERROR MESSAGE

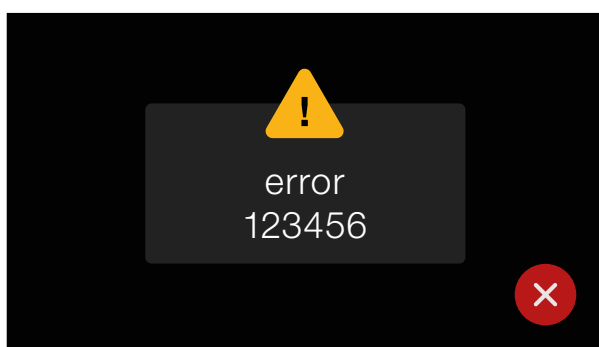

In case of error disconnect and reconnect the appliance.
If the error is present again you will need the intervention of an authorized technician

DOOR OPEN MESSAGE (DURING OPERATION)

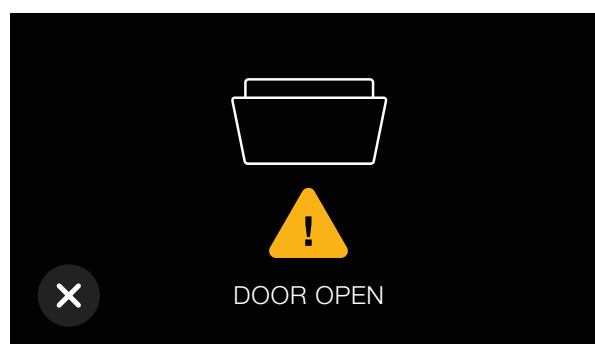

Close the oven door.



: GAS oven fails to light. To continue cooking, touch the start button. If the symbol appears again, check that the system’s GAS valve is open.

PROBLEM SOLVING

– Children Lock

How to resolve

Symbol that represents the children lock

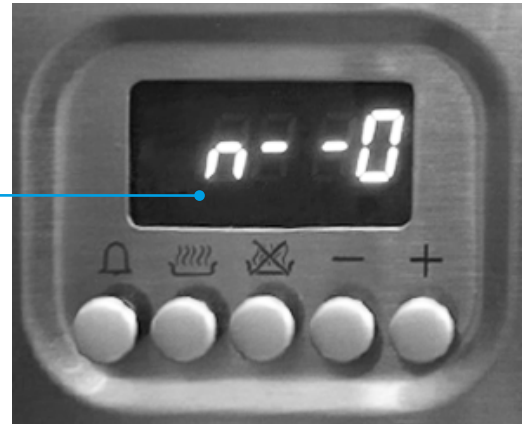

ATTENTION:



If this symbol shows up in your oven, do not worry. The children lock may have accidentally been selected.

The oven is equipped with a safety feature which prevents the unwanted startup of the oven.

How to disable

To disable the safety lock, hold the thermostat knob which regulates the temperature for 5". On the display will appear "n—o" followed by "OFF".

How to activate

To activate the safety lock, hold down the thermostat knob for 5", with the oven turned off. You'll hear a short acoustic signal and, on the display, will appear "n—o" followed by "ON".

It will then not be possible to start up the oven.

COOKING CHART

– Convection oven (purely indicative values)

DISH	TEMP. C°		MIN.
MEATS			
Roast beef	170-180	2/3	40/50
Roast ox	170-190	2/3	40/60
Roast veal	160-180	2/3	65/90
Roast lamb	140-160	2	100/130
Rare roast beef	180-190	2/3	40/45
Roast hare	170-180	2/3	80/100
Roast rabbit	160-170	2	80/100
Roast turkey	160-170	2	160/240
Roast goose	160-180	2/3	120/160
Roast duck	170-180	2/3	100/160
Roast chicken	180	2/3	90/120
FISH	160-180	2/3	15/25
CAKES			
Fruit cake	180-200	2	40/50
Plain square cake	180-190	2	40/45
Brioches	170-180	2	40/60
Sponge cake	190-200	2	25/35
Plain ring cake	160-180	2	35/45
Sweet biscuits	180-200	2	20/30
Yeast cake	190-200	2	30/40
Strudel	160	2	25/35
Savoy biscuits	150-180	2	50/60
Apple fritters	180-200	2	18/25
Biscuits pudding	170-180	2	30/40
DISH			
Bread	180-200	3	45
Pizza	250	3	10/20
Toast	185-195	2	7

IMPORTANT



Insert foods when the oven is hot.

«Grill» baking

Cooking with the electric grill is done at 180° C with the door closed. The food to be grilled should be placed on the relative grid preferably in the fourth shelf.

COOKING CHART

– Static oven (purely indicative values)

DISH	TEMP. C°		MIN.
MEATS			
Roast beef	225	2/3	60/80
Roast ox	250	2/3	50/60
Roast veal	225	2/3	60/80
Roast lamb	225	2	40/50
Rare roast beef	230	2/3	50/60
Roast hare	250	2/3	40/50
Roast rabbit	250	2	40/50
Roast turkey	250	2	50/60
Roast goose	225	2/3	60/70
Roast duck	250	2/3	45/60
Roast chicken	250	2/3	40/45
FISH	200-225	1/2	15/25
CAKES			
Fruit cake	225	2	35/40
Plain square cake	175-200	2	50/60
Brioches	175-200	2	25/30
Sponge cake	220-250	2	20/30
Plain ring cake	180-200	2	30/40
Sweet biscuits	200-220	2	15/20
Yeast cake	250	2	25/35
Strudel	180	2	20/30
Savoy biscuits	180-200	2	40/50
Apple fritters	200-220	2	15/20
Biscuits pudding	200-220	2	20/30
DISH			
Bread	220		30
Pizza	250	2	15/20
Pizza	250	3	10/20
Toast	250	3	5

IMPORTANT

Insert foods when the oven is hot.

«Grill» baking

Cooking with the electric grill is done at 180° C with the door closed. The food to be grilled should be placed on the relative grid preferably in the fourth shelf.

COOKING CHART

Inside food temperature (°C)

COOKING CHART	Food	Temperature (°C)
	Beef	
	• Roastbeef / beef fillet	
	rare	40-45
	medium	50-55
	well done	60-65
	• Roast meat	80-85
	Pork	
	• Loin	65-70
	• Roast / bacon	80-85
	• Neck	80-85
	• Pork chop	75-80
	• Cutlet	70
	• Marinated cutlet	65-70
	• Meat loaf	70-75
	Veal	
	• Roast veal	70-75
	• Roast veal with kidney	75-80
	• Veal feet	80-85
	Game	
	• Game meat	75-80
	• Back	60-70
	• Rare fillet	40-45
	• Medium	50-55
	• Welldone fillet	60-65
	Lamb	80-85
	Stuffed roasts	70-75
	Poultry	85-90
	Fish	85-90

Remark

Probe must be in the middle of the roast and not close to the bone or to any fat part

